



LAS POSITAS COLLEGE

SPRING 2024 CLASS SCHEDULE



Invest in
you



**Spring classes
begin in January**
www.laspositascollege.edu

Guaranteed transfer
to UC or CSU...
See page 73

Enroll today
in the Best Community
College in the East Bay

MESSAGE FROM LAS POSITAS COLLEGE

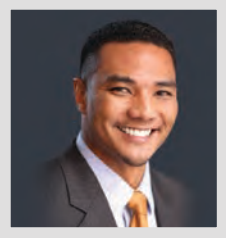

Welcome to Las Positas College!

As you may know, Las Positas College has been ranked the #1 community college in all of California and the 6th best community college in America! I am excited that you have made the decision to join us for the spring 2024 semester, to pursue your educational goals and career aspirations. You've made a great choice!

Our caring and dedicated faculty, staff, and administrators are committed to supporting you throughout your entire college experience. We have outstanding student support services, academic resources, and excellent opportunities for you to be involved in campus life. I am confident that you will find that Las Positas College is a fun place to be. You will have the opportunity to meet new people, while you prepare to transfer to a four-year college or university or to enter the workforce in your chosen career.

The most important thing for you to know is that we care about you and your success. You are not alone on your educational journey; our faculty and staff are here to assist and support you, from your first semester all the way through graduation! I encourage you to make the most of your LPC experience and take advantage of the many student resources and opportunities that are available to you.

As you will discover, LPC is committed to excellence in teaching and learning, student success, and student completion. We strive to be outstanding in all we do; to serve all students by providing opportunities for economic mobility for their families, and to serve our community by contributing to the talent pipeline within our region.

I am excited to welcome you to the new semester at LPC and I wish you much success!

Sincerely,

Dr. Dyrell Foster

President, Las Positas College

WELCOME TO THE LPC COMMUNITY!



Photo Credit: Doug Jorgensen



BOARD OF TRUSTEES

Tim Sbranti, President
Maria L. Heredia, Secretary
Hal G. Gin, Ed.D.
Linda Granger

Stephen Lanza
Harris Mojadedi
Luis Reynoso, Ed.D.

PRESIDENTS

Dyrell Foster, Ed.D., President, Las Positas College
Jamal A. Cooks, Ph.D., President, Chabot College

CHANCELLOR

Ronald P. Gerhard, Chancellor



**CHABOT
LAS POSITAS**
COMMUNITY COLLEGE DISTRICT



MISSION STATEMENT

Las Positas College provides an inclusive, learning-centered, equity-focused environment that offers educational opportunities and support for completion of students' transfer, degree, and career-technical goals while promoting life-long learning.

VISION STATEMENT

Las Positas College strives to support and empower students to develop the knowledge, skills, values, and abilities needed to become engaged participants and leaders in their local and global communities.

VALUES STATEMENT

Las Positas College thrives as a collaborative teaching and learning community committed to integrity and excellence by:

1. Encouraging and celebrating lifelong learning
2. Responding to the needs of the ever-changing workplace and society
3. Demonstrating civic, social and environmental responsibility
4. Promoting ethical behavior, mutual trust, equity, and respect within our diverse community
5. Fostering a climate of discovery, creativity, personal development, and physical and mental health
6. Committing to anti-racist policies and practices.
7. Ensuring that Las Positas is a sanctuary campus for undocumented students
8. Holding firm to the belief that each of us makes an astonishing difference.

ACCREDITATION

Las Positas College is accredited by the Accrediting Commission for Community and Junior Colleges of the Western Association of Schools and Colleges.

TABLE OF CONTENTS

Mission, Vision and Values	1	Explanation of Terms used in the Course Listings on CLASS-Web.....	21
District Vaccine Info	1	Spring Course Listings	22-64
Invest in You	2	Math Pathways Info	65-66
Steps to Success.....	3	Fees and Payment Policy	67-68
Spring 2024 Academic Calendar ..	4	NelNet Payment Program	67
Registration Dates.....	5	Financial Aid	69
ZoneMail Info	6	BCRC Information	70
How to Forward Your ZoneMail to Your Personal Email	78	Academic and Student Support Services.....	71-73
HyFlex Info	7	Umoja Flyer	74-75
Admission Information	8-9	College Policies and Procedures....	76-78
Course Registration Procedures....	10	Campus Safety and Security	79-81
Enrollment Policies and Procedures..	11-12	Parking Permits	82
Pronto Info	12	Emergency Alert System.....	82
Orientation, Assessment and Educational Plan.....	13	Bookstore Information.....	83
DegreeWorks Info	14	Transit (Bus) Pass Information	83
Degree, Certificate and Transfer Programs	15-16	Final Exam Schedule.....	84-85
Mini Market Info.....	17	Campus Directory	86
Spring 2024 Courses	18-64	Campus Map.....	87
Description of Section Types	19-20	New! 3D Campus Map Info.....	88

The Chabot-Las Positas Community College District Board of Trustees voted to suspend the COVID-19 vaccine mandate, effective April 24, 2023. Students registering for Spring classes for 2024 will no longer need to provide proof of COVID-19 vaccination.

Courses, dates, and times are subject to change without notice. Refer to the college website for the most current course information.



LAS POSITAS
COLLEGE



INVEST IN *you*

Nothing should stand in the way of your future. That's why financial aid is available to most students who need it. Get help paying for college costs like tuition and books to help you reach your educational and career goals.

- Learn within your budget
- Earn more with a degree
- Get the money to pay for the education you deserve

YOU CAN AFFORD COLLEGE!

STEPS TO SUCCESS



STEP 01

Apply For Admission.



STEP 02

Apply For Financial Assistance.



STEP 03

Complete An Online Orientation.



STEP 04

Complete Placement and or Assessment



STEP 05

Complete Your Student Education Plan.



STEP 06

Register For Classes.
Pay Fees!

Enroll Now: <http://www.laspositascollege.edu/stepstosuccess/newstudent.php>

ACADEMIC CALENDAR

Registration Dates for SPRING 2024

November 7.....	STATE MANDATED - CalWORKs, DSPS, EOPS/CARE, Foster Youth, Homeless, and Veterans begins
November 9.....	COLLEGE PRIORITY - Student Athletes, Student Government Officers, International Students, Puente Students, and Umoja Students begins
November 13.....	Continuing students with <u>3 Core Services completed</u> begins
November 15.....	New students with <u>3 Core Services completed</u> begins
November 15.....	Returning students with <u>3 Core Services completed</u> begins
November 16.....	Continuing students who have not completed the <u>3 Core Services</u> begins
November 21.....	Students on probation, dismissed status, or those who have completed 100 or more degree applicable units at LPC or Chabot College
November 27.....	OPEN REGISTRATION
November 29.....	Special Admit/ Concurrent Enrollment students (Grades 8 - 12) - Registration begins

For more detailed information on priority groups and registration, see page 5.

Concurrent Enrollment Application Due Date

October 13, 2023 - January 5, 2024.....Accepting Concurrent Enrollment Applications for Spring 2024

SPRING 2024 Semester Calendar (DATES APPLY TO FULL-TERM CLASSES ONLY)

January 15.....	HOLIDAY - Martin Luther King, Jr. <i>(no instruction)</i>
January 16, 2024.....	Spring semester begins <i>(full-term classes only)</i>
January 16 - February 4.....	<u>Late enrollment</u> for full-term classes – on a space-available basis. Register online through CLASS-Web or in-person with add authorization number
January 17.....	Associate Degree and/or Certificate of Achievement filing period begins through April 1
January 20.....	Instruction begins for Saturday classes
February 4.....	Last day to ADD/DROP with No Grade-of-Records (NGR) via CLASS-Web <i>(full-term classes only)</i>
February 5.....	CENSUS date <i>(full-term classes only)</i>
February 16 - 19.....	HOLIDAY – Presidents' Weekend <i>(no instruction)</i> College closed
March 2.....	Priority California Financial Aid Deadline
March 21.....	Flex Day <i>(All classes scheduled before 4:00 pm canceled; however, classes beginning after 4:00 pm will meet as scheduled)</i>
March 30.....	Saturday Classes Meet
April 1.....	Deadline to apply for an Associate Degree, Certificate of Achievement, and/or Career Certificate
April 1 - 6.....	SPRING BREAK <i>(no instruction / no Saturday classes)</i>
April 14.....	Last day to WITHDRAW with a "W" via CLASS-Web <i>(full-term classes only)</i>
May 11.....	Last day of Saturday classes
May 17.....	Last day of Instruction
May 17.....	Last day to request Pass/No Pass
May 18.....	Final Exams for Saturday classes
May 20 - 24.....	Final Examination Period
May 24.....	Commencement/Graduation*
May 27.....	HOLIDAY - Memorial Day <i>(no instruction)</i>
June 2.....	Instructors – Spring 2024 grades due by 11pm via CLASS-Web
Week of June 10, 2024.....	Students - Spring 2024 grades available via Class-Web

**Additional information regarding commencement is sent throughout the semester by the Office of the Vice President of Student Services.*

SPRING 2024

Drop for Non-Payment Deadline

Must Pay by

Students who register for Spring classes between Nov 7 - Nov 28, 2023Dec 7, 2023

IMPORTANT: Drop for non-payment will be processed on Dec 8, 2023.

REGISTRATION DATES - SPRING 2024

Your registration priority group and registration date are determined by the completion of the Three Core Services (Orientation, Assessment, and Student Educational Plan), the number of units completed and in-progress at Chabot-Las Positas Community College District, and maintaining good academic standing.

The registration date shown below is the first day that a student is eligible to register for classes based on their priority group. Students may continue to register for classes any day after their priority registration date.

STUDENT STATUS	CRITERIA FOR GROUP	REG DATE
CalWORKs DSPS EOPS/CARE Foster Youth Homeless Veterans	STATE MANDATED PRIORITY GROUPS <ul style="list-style-type: none"> • Must complete all 3 Core Services • Must be in good academic and progress standing • Must have less than 100 degree applicable units 	Nov 7
Student Athletes Student Government Officers International Students Puente Students Umoja Students	COLLEGE PRIORITY GROUPS The only students in this priority group are noted in the left column. <ul style="list-style-type: none"> • Must complete all 3 Core Services • Must be in good academic and progress standing • Must have less than 100 degree applicable units 	Nov 9
Continuing Students who COMPLETED all 3 Core Services	CONTINUING STUDENT REGISTRATION SCHEDULE Priority registration date is based on the following: <ul style="list-style-type: none"> • Completion of all 3 Core Services • Good academic and progress standing • Must have less than 100 degree applicable units • And total units completed (including in-progress units) <ul style="list-style-type: none"> • 60 - 99.9 units will register on Nov 13, 2023 • 45 - 59.9 units will register on Nov 13, 2023 • 30 - 44.9 units will register on Nov 14, 2023 • 15 - 29.9 units will register on Nov 14, 2023 • 0.5 - 14.9 units will register on Nov 14, 2023 	Nov 13 -14
New Students	NEW STUDENTS eligible for this registration date are: <ul style="list-style-type: none"> • Students who have completed all 3 Core Services • Students enrolled in less than 0.5 units 	Nov 15
Returning Students	RETURNING STUDENTS are eligible for this registration date if they: <ul style="list-style-type: none"> • Completed all 3 Core Services • Are in good academic and progress standing • Have less than 100 degree applicable units 	Nov 15
Continuing Students who HAVE NOT completed all 3 Core Services	CONTINUING STUDENTS are eligible for this registration date if they: <ul style="list-style-type: none"> • Have not completed all 3 Core Services • Are in good academic and progress standing • Have less than 100 degree applicable units <ul style="list-style-type: none"> • CalWORKs, DSPS, EOPS/CARE, Foster Youth, Homeless, and Veterans will register on Nov 16, 2023 • Student Athletes, Student Government Officers International Students, Puente Students, and Umoja Students will register on Nov 16, 2023 • 30 - 99.9 units will register on Nov 17, 2023 • 0.5 - 29.9 units will register on Nov 20, 2023 	Nov 16 - 20
Students on Probation/Dismissal Excessive Units	<ul style="list-style-type: none"> • Students who have been on Academic and/or Progress Probation for two consecutive semesters and/or have been placed on Academic and/or Progress Dismissal • Students with over 100 degree-applicable units 	Nov 21
OPEN REGISTRATION All Students (except High School Concurrent Enrollment Students)	Open Registration begins for students: <ul style="list-style-type: none"> • Who have not completed all 3 Core Services • Admitted to the College after all groups have registered 	Nov 27
Concurrent Enrollment	Concurrent Enrollment Registration Begins (Grades 8 - 12) applying for Spring 2024	Nov 29

ZONEMAIL INFORMATION



Here are three ways **ZoneMail** keeps you connected

1

Check your **ZoneMail** often, especially during registration periods and the beginning of each semester. You can also forward your **ZoneMail** to your personal email.

2

All the important information you need about your experience at LPC will be sent to your student email:

- Registration
- Financial aid
- Student deadlines
- Emergency alerts
- Waitlist

3

You may check your student email on campus. Simply sign up for **ZoneMail** OR forward to your personal email:
<http://laspositacollege.edu/ZoneInfo/index.php>

STAY INFORMED, FOLLOW US:
WWW.LASPOSITACOLLEGE.EDU

 LAS POSITAS COLLEGE
 @LPCOFFICIAL

 LASPOSITACOLLEGE
 LAS POSITAS COLLEGE

NEED HELP? ASK THE HELPZONE! Call (925) 424-1710 or send email to helpzone@clpccd.org



LAS POSITAS
COLLEGE

When your busy schedule
requires an education that is

Flexible,
stay on track with
HyFlex!

Las Positas College offers a wide variety of classes in the HyFlex modality.

The term "HyFlex" combines the words "hybrid" and "flexible."

That means the section has both on-campus and online sessions (hybrid) and gives you a choice of how you want to attend (flexible).

HYBRID A mix of both face-to-face sessions and online sessions.

FLEXIBLE Learners choose their method of participation per class session.

HYFLEX Your class meets face-to-face, and you may choose to attend in-person or to attend synchronously. Some instructors may offer asynchronous options.



Learn more and check out our list of HyFlex courses:
laspositascollege.edu/onlinelearning/hyflex.php

ADMISSION INFORMATION

WHO MAY ATTEND LAS POSITAS COLLEGE

Admission is open to anyone who is:

- 18 years of age or older; or
- A high school graduate or completed a high school equivalency test, General Education Degree (GED) or California High School Proficiency Exam;
- A high school student currently enrolled in 10th, 11th or 12th grade may participate in the Concurrent Enrollment Program.

HOW TO APPLY FOR ADMISSION

Apply online at www.laspositascollege.edu

You will be asked to create an account on CCCApply before being directed to the application. After the application has been received, you will be sent an email confirmation with additional information. You will also receive a student identification number (which begins with a "W"). Use this number to conduct all college business and access college services. You may also log into CLASS-Web to obtain your "W" student identification number.

COMMUNICATION VIA ZONEMAIL ACCOUNT

All admitted students are given a student email account through The Zone web portal. All messages from the College are sent to this account. Registration dates will be emailed to your ZONEmail account. As you complete your 3 Core Services, you may be eligible for an earlier registration date than previously assigned. Please check your ZONEmail regularly for important notices from the College.

- Go to www.laspositascollege.edu
- Click on "The ZONE"
- User ID: use your W number
PIN: Same six-digit pin used for CLASS-Web
- Log in and click "What is my college/district email address?" link under "Quick Check"
- Click the Email icon and log in with the email as your username, and password (same six-digit pin used for The ZONE and CLASS-Web)

Instructions on "how to forward your ZONEmail" to your personal email are located on page 12. In addition to registration date notifications, students will also receive waitlist information, instructor emails, Financial Aid notifications, and general College information.

STUDENT DEFINITIONS	
NEW STUDENT	You are a new student if you have never registered in classes at LPC. Apply online.
RETURNING (FORMER) STUDENT	You are a returning student if you have <u>not</u> attended LPC during the past two semesters. Reapply online.
CONTINUING STUDENT	You are a continuing student if you have attended LPC during at least one of the two most recent semesters. Do not reapply.
CONCURRENT ENROLLMENT STUDENT	You are currently a high school student enrolled in grade 10, 11, or 12. An admission application and supplemental paperwork is required for each semester/term of attendance.

ENROLLMENT STATUS BASED ON UNIT LOAD

Full-time student	Registered for 12 or more units
Three-quarter student	Registered for 9.0 to 11.5 units
Half-time student	Registered for 6.0 to 8.5 units
Less than half-time student	Registered for 0.5 to 5.5 units
Noncredit only student	Registered for 0.0 units

RESIDENCY

For purposes of determining enrollment fees, students are identified as either residents or nonresidents.

Residents:

Those who have lived in California as legal residents for at least one year and one day prior to the first day of a new semester/term and who can demonstrate intent to remain a California resident. Noncitizens who meet residency requirements and who desire to enroll as a California resident must provide documentation.

Nonresidents:

Those who do not meet the California resident requirements. In addition to the enrollment fee, nonresident students are required to pay nonresident tuition. For further information concerning residence status, please contact the Admissions and Records Office.

NONRESIDENT TUITION EXEMPTION (VACA)

Military veterans may be eligible for a tuition exemption based on VACA (Veterans Access, Choice and Accountability Act) criteria. Veterans who qualify for Chapter 30 or Chapter 33 GI Bill, who live in California and enroll from active duty service of 90 days or more may be eligible for exemption of payment of nonresident tuition. For additional information, please contact the Veterans First Program.

NONRESIDENT TUITION EXEMPTION (AB540)

A California Nonresident Tuition Exemption may be granted to certain nonresident students who meet the exemption requirements set forth in Assembly Bill 540. To be eligible, students must have attended high school in California for three or more years, or attainment of credits earned in California from a California high school equivalent to three or more years of full-time high school coursework and a total of three or more years of attendance in California elementary schools, California secondary schools, adult schools, or a combination of those schools. In addition, students must have graduated or will graduate from a California high school or obtained a certificate or General Education Development (GED), High School Equivalency Test (HiSET), or Test Assessing Secondary Completion (TASC), or attainment of an AA degree from a California Community College, or fulfillment of the minimum requirements to transfer to a UC or CSU. Students must also complete an affidavit to legalize immigration status as soon as possible, if applicable. For additional information contact the Admissions and Records Office.

NONRESIDENT TUITION EXEMPTION (REFUGEES AND SPECIAL IMMIGRANT VISA HOLDERS)

In 2017, the California Legislature enacted Assembly Bill 343, which established a new exemption from nonresident tuition for refugees with special immigrant visas (SIVs). For additional information, contact the Admissions and Records Office.

ADMISSION INFORMATION

NONRESIDENT TUITION EXEMPTION (CH 31 – VOCATIONAL REHABILITATION AND EMPLOYMENT)

Out-of-state student Veterans under chapter 31, Vocational Rehabilitation and Employment (VR&E), will be charged the resident rate, effective after Spring 2019 semester.

NONRESIDENT TUITION EXEMPTION (CONCURRENT ENROLLMENT)

Concurrently enrolled students (high school students enrolled in college classes) who are classified as nonresident students for tuition purposes may be eligible for the Senate Bill 2364 waiver of nonresident tuition while still in high school.

Students must be special admit part-time (enrolled in 11 units or less) students who currently reside in California and are attending high school in California. Students wishing to take advantage of this exemption should complete a nonresident exemption form and provide a copy of high school transcripts showing current enrollment. Documentation should be submitted to the Admissions and Records Office.

INTERNATIONAL STUDENTS

Las Positas College welcomes international students and is authorized under federal law to enroll nonimmigrant alien students (F-1 and M-1 visa). Students seeking admission to Las Positas College must submit a completed International Student Application packet and other required supplemental application documents including a non-refundable \$100 application fee, academic transcripts or certificates, proof of English language proficiency, evidence of financial support, and health examinations. The International Student Application packet with information on the specific language proficiency requirements and alternative forms of English language proficiency accepted and amount of adequate financial support may be found on the International Student Program's website at: www.laspositascollege.edu/international.

The completed application may be scanned, mailed or faxed to the International Student Program office. To be considered for admission, students must submit all required materials by the deadline posted on the International Student Program's website. Due to the visa application process at U.S. Embassies and Consulates, overseas applicants are strongly encouraged to apply as early as possible. Students currently studying on an F-1 visa at another school in the United States may apply to transfer to Las Positas College. Please contact the International Student Program for more information.

MIDDLE COLLEGE

Middle College is an alternative education collaboration between Las Positas College and the Tri-Valley Regional Occupational Program. Middle College provides high school students from Dublin, Livermore, and Pleasanton an opportunity to begin taking college courses while still enrolled in high school. Juniors and Seniors take classes at Las Positas College (up to 11 units per semester) and there is no cost to the student for materials, enrollment fees, or tuition. Middle College is an excellent opportunity for high school students to complete curriculum required for high school graduation, get started on their college education, and begin to prepare for the workforce. Additional information is found on the college website. An application process for Middle College is open to students in the three Tri-Valley ROP districts: Dublin Unified School District, Livermore Valley Joint Unified School District, and Pleasanton Unified School District. The application process opens mid-January for the following school year.

CONCURRENT ENROLLMENT PROGRAM

Las Positas College provides opportunities for students in 9th, 10th, 11th, and 12th grades to enroll in college-level, degree-applicable courses. Students in or entering 8th grade may be admitted through special agreements between Las Positas College and school districts.

ELIGIBILITY

1. Must be recommended by their high school principal, or designee.
2. Must have written parental permission.

NOTE: *Concurrent Enrollment students are not allowed to enroll in basic skill courses (English 100 level, all ESL courses, Math 100 level) (Ed. Code 48800).*

CONCURRENT ENROLLMENT ADMISSION CHECKLIST

1. Complete the online Admission application and print the confirmation page for your records.
2. Fill out the **REQUIRED** Concurrent Enrollment Recommendation Form through AdobeSign. Paper copies will not be accepted.
3. Students attending home school should also submit a copy of their R4 Private School Affidavits. (CA Ed Code, section 33190).
4. You must consult the College Catalog to determine if any requested classes have prerequisites. All prerequisites must be completed and cleared prior to registration. For more assistance with prerequisites, visit the Counseling Office.

IMPORTANT: *Students who wish to enroll in English and/or Math must still take the Assessment test or clear the prerequisite via Counseling. Visit the Assessment Center website for more information.*

HIGH SCHOOL CONCURRENT ENROLLMENT REGISTRATION

for the Spring 2024 term begins:

November 29, 2023

Students may begin submitting all required documentation through AdobeSign on the dates listed below:

October 13, 2023 - January 5, 2024 – Accepting High School Concurrent Enrollment Applications for SPRING 2024

After January 5, the High School Concurrent Enrollment program for the Spring 2024 term will be closed.

NOTE: *Concurrently enrolled students will be permitted to enroll in a maximum of 11 units for Fall, Spring, and Summer semesters. Students will be treated as regular college students and are expected to comply with all college rules and regulations.*

Documentation received after the established deadline is not guaranteed to be accepted for enrollment. Once your packet is processed, an email will be sent with registration information. All students are strongly advised to complete assessments. High School students must complete an online application and the required concurrent enrollment materials each semester and must have a high school grade point average (GPA) of 2.0 or higher.

FEES

Enrollment fees are waived for students in the Concurrent Enrollment Program. However, the Student Rep Fee (\$2.00), the Health Services Fee (\$21 for Fall and Spring, \$18 for Summer), and the Transportation fee (\$8 or \$9 for Fall and Spring) are mandatory. International, nonresident, and out-of-state students will be assessed tuition of \$360 + \$46 = \$406 per unit. Materials fees apply to some classes.

COURSE REGISTRATION PROCEDURES

ADDING CLASSES

1. Go to www.laspositascollege.edu
2. Login to CLASS-Web
3. Select the Student Services tab
4. Click the Registration link
5. Click the Add/Drop or Withdraw from Classes link
6. Select the term and click the Submit button
7. Enter the course registration number (CRN)
8. Click the Submit Changes button

WAITLIST

Students may reserve a space on the waitlist for courses that are closed due to reaching their maximum enrollment limit. During registration, students will be automatically prompted to sign up for the waitlist if the class is closed.

Students cannot add themselves to the waitlist if one of the following conditions exist:

- a. Course prerequisites/corequisites not met;
- b. Registration holds;
- c. Waitlist class overlaps in time with classes already registered for;
- d. Already on a waitlist for the same class. (However, students may add themselves to waitlists for different classes); or
- e. Adding to the waitlist exceeds the maximum unit load of 18 units.

WAITLIST NOTIFICATIONS

All notifications for waitlist will be emailed to the student's Zonemail account. If a seat becomes available for a course, the student at the top of the waitlist receives a notification email to register for that class within 72 hours. If the student does not take action before the stated expiration date and time, the student loses their spot to the next student on the waitlist and is removed from the waitlist.

ADD AUTHORIZATION NUMBERS

The Add Authorization Number reserves your seat in the class and it is only valid before the census date. Please check the academic calendar. If you miss the course add deadline, you will need to contact your instructor and ask to be added. Your instructor will then submit a late add request online directly to the Admissions and Records office.

Students who are on the waitlist and wish to add should attend the first day of class. Instructors will issue add authorization numbers to students in the order that they appear on the waitlist. After waitlist students have been accommodated, the instructor may add any remaining students by priority number.

Students who have received an add authorization number from the instructor may then enter the 6-digit add code via CLASS-Web or The Zone. The student must add the class by the add deadline (see Academic Calendar).

HOW COURSE "ADD" PRIORITY IS DETERMINED

Only the last four digits of the priority number are considered by an instructor at the beginning of each course when determining "add" priority for additional students. The "add" priority number for new students will be zero for their initial semester of enrollment. Students may attempt to add into open

classes during the add period at the beginning of a term or semester. Students are generally added from highest to lowest priority number.

Instructors will issue add authorization numbers to students in the order that they appear on the waitlist. After waitlist students have been accommodated, the instructor may add any remaining students by priority number.

LATE REGISTRATION

(First two weeks of semester)

If you were unable to submit your application and register for classes before the semester begins, you will need to complete the following:

1. **Submit an application online;**
2. **Attend class (Do not wait for your application to be processed);**
 - Obtain an ADD AUTHORIZATION NUMBER from the instructor. Be sure to have your priority number available. Reminder: If there is space available, instructors will add according to waitlist priority before issuing adds to non-waitlisted students.
3. **Register**
 - Enter the 6-digit add authorization number on CLASS-Web when prompted to do so in the registration menu.

Refer to the "Late Start" section for available courses. ADD/DROP dates for these courses may vary from full term courses.

STUDENT ID CARD

All students are required to carry a valid photo identification card with current validation sticker. This card is essential for use of library, computer lab, bookstore, Wheels (bus transportation) and other campus services. Cards may be obtained at Admissions and Records, Building 1600.

COMMON REGISTRATION ERROR MESSAGES

EXCESS UNITS	Students are eligible to take up to 18 units. If a student wishes to take more than 18 units he/she must consult with a Counselor.
CLASS OVERLAP	Students may be permitted to enroll in two classes that meet during any part of the same hour with approval from the instructor, but only if a class overlaps with another class for 15 minutes or less. The class overlap approval form is accessible on the LPC website under the Admissions & Records page. The form must be filled out by the instructor and signed by the appropriate Dean. The Division Dean will forward the completed form to the Admissions and Records Office. If approved, the Admissions & Records Office will notify and advise the student to register in the class.
REPEAT LIMIT EXCEEDED	The student must consult with the Counseling Department.
PREREQUISITE NOT MET	The student must consult with the Counseling Department.

ENROLLMENT POLICIES & PROCEDURES

OPEN COURSE POLICY

In accordance with District Policy, all classes are open to enrollment and participation by any person who meets the academic prerequisites of the class and who is otherwise eligible for admission to Las Positas College.

CLOSED AND CANCELLED CLASSES

Any class may be closed to further registration when it reaches the maximum size. Additionally, if registration is insufficient in any class, it may be cancelled.

DROPPING CLASSES (“NGR”) AND CLASS WITHDRAWAL (“EW”, “W”)

Students are responsible for dropping or withdrawing from classes. Failure to follow the withdrawal procedures may result in a grade of “F” or “NP”.

(“NGR”) No Grade of Record

Students who drop on or before the NGR (No Grade of Record) deadline date will not have a notation/grade appear on their academic record. Students may apply for a refund through the Admissions and Records Office. For course cancellations, students may be eligible for a refund.

(“EW”) Excused Withdrawal

Excused Withdrawal occurs when a student is permitted to withdraw from a course(s) due to specific events beyond the control of the student affecting his or her ability to complete a course(s). Upon consultation with the course faculty and verification of these conditions or reviewing documentation substantiating the condition, an excused withdrawal symbol may be assigned “EW.” The “EW” shall not be counted in progress probation and dismissal calculations.

(“W”) Withdrawal

Class withdrawals that occur after the NGR drop period and prior to the “W” (Withdrawal) deadline date will result in a “W” notation on the student’s academic record. Students are subject to all course fees and/or tuition. “W” grades do not affect the student’s grade point average (GPA). However, excessive “W” notations may result in poor progress or dismissal status and may affect financial aid, athletic eligibility, and/or priority registration.

Note: Instructors have the option of dropping students who: (a) do not attend either of the first two class meetings; or (b) have excessive absences of four consecutive or six cumulative hours.

REPEATING A COURSE

California regulations specify the circumstances under which a student may repeat a course per CA Ed Code §55040 - §55045.

Procedures for Course Repetition

A “Petition to Repeat a Course” request may be submitted to the Dean of Student Services or designee for consideration when the student has been blocked due to exceeding the limit of 3 attempts. This petition is required for approval of repetitions beyond the limits noted in California regulations. An unofficial transcript and personal statement is required and

should be attached to the Petition to Repeat a Course form.

Students are advised that both the original and subsequent grade will remain on their transcript and that in transferring to another institution, they may be held responsible for all units attempted.

Please refer to the College Catalog for detailed information regarding course repetition policies and procedures.

COURSE PREREQUISITES

A prerequisite is a requirement that must be completed prior to the registration of a course. “Prerequisite” refers to the preparation or previous course work considered necessary for success in the course. The college requires students to complete prerequisites as pre-enrollment preparation. Prerequisites, which are listed in the College Catalog, include:

1. Courses for which specific prerequisites have been validated.
2. Sequential course work in a degree-applicable program.
3. Courses in which a prerequisite is necessary for transfer to a four-year college.

PREREQUISITE OVERRIDE POLICY

Official transcripts are not evaluated upon receipt by the Admissions and Records Office. If a student completed an equivalent course at another institution, s/he must submit a Prerequisite Override Request to the Counseling Department.

Visit the Counseling website at:

www.laspositascollege.edu/counseling for more information regarding how to meet with a counselor.

ACADEMIC AND PROGRESS PROBATION

There are two types of probation: Academic and Progress. Students placed on probation may be required to meet with a Counselor to identify the deficiencies that created the probation status, develop success strategies needed to resolve the problem, and to develop a student educational plan for the upcoming semester.

RE-ADMISSION FROM DISMISSED STATUS

Students who have been dismissed from Las Positas College for scholastic reasons may petition for readmission if eligible under College policy outlined in the College Catalog. After completing the online application, students must submit a “Petition for Admission from Dismissed Status” to Counseling.

OFFICIAL COLLEGE TRANSCRIPTS

Las Positas College provides a third-party online transcript ordering system through Parchment Inc. Parchment is an efficient and accurate Transcript Ordering System created for the engaged student. Parchment also provides many transcript delivering options for a student to choose from. The Las Positas College Transcript webpage is located under the Admissions tab and provides additional information and a direct link to Parchment Inc.

Las Positas College offers two free transcripts for all students.

ENROLLMENT POLICIES & PROCEDURES

Free transcripts take ten business days to process and are sent first class mail through the U.S. Postal Service. Once the transcript leaves our college, it is the responsibility of the USPS to deliver. Mailing is not trackable or guaranteed. Lost transcripts may result in having to request and pay for additional copies. The Las Positas College Transcript webpage, located under the Admissions tab, provides a direct link to the Transcript Request Form. All other services are provided only through Parchment Inc.

Pick up service is not available for both free and Parchment transcript orders. Unofficial transcripts are accessible through the student's Class-Web account.

CROSS ENROLLMENT WITH CALIFORNIA STATE UNIVERSITY, EAST BAY

Students who have completed 20 transferable units at Las Positas College with a 2.0 cumulative grade point average (GPA) may be eligible to cross enroll with California State

University (CSU), East Bay while completing coursework at Las Positas College. Students may elect to cross enroll in courses at CSU East Bay which are not offered by Las Positas College including upper division courses. Students must be enrolled in a minimum of 6 units at Las Positas College and 12 units between the two campuses. For more information, contact the Counseling Department.

CROSS ENROLLMENT WITH UNIVERSITY OF CALIFORNIA, BERKELEY

Students who have completed one semester as a matriculated student at Las Positas College with a 2.0 cumulative grade point average (GPA), and are currently enrolled in a minimum of six units, may be eligible to cross enroll with the University of California (UC), Berkeley. A maximum of one course per term at UC Berkeley is allowed, and enrollment is on a space available basis. Additional requirements apply. For more information, contact the Counseling Department.



Student engagement starts here.

Pronto is a **CANVAS integrated** app that allows you to communicate with faculty, classroom communities and to receive important messages from the college. Download the app to your phone, pronto!



ORIENTATION, ASSESSMENT & STUDENT EDUCATIONAL PLAN

Welcome to Las Positas College! As part of our shared commitment to your educational success, we offer a number of programs and services to help you reach your educational goals. Three important “Core Services” that are highly encouraged for priority registration are: Orientation, Assessment, and the Student Educational Plan (SEP). Learn about each of these essential services below:

CORE SERVICE 1: ORIENTATION

To help with your transition to LPC, an online orientation is offered for all students, including first-time college students and returning students. Within the orientation, members of the LPC community will introduce you to the school's programs, services, academic regulations, expectations, campus facilities, and student life. You will need your LPC student identification number that was assigned to you to complete the online orientation. Completion of the orientation is required to participate in priority registration at LPC. Visit <https://bw11.clpccd.cc.ca.us/> to access the online orientation at the website.

CORE SERVICE 2: ASSESSMENT/PLACEMENT

In order to help determine the proper course placement for you to begin your educational career at LPC, all students are encouraged to complete the Guided Self Placements for Math and English. The Assessment Center also offers placement for English as a Second Language, Chemistry and Foreign Language (Spanish and French) courses. Completion of the Guided Self Placement for Math and English or assessment for English as a Second Language is required to participate in priority registration at LPC. Visit the Assessment Center homepage for more information. If you have a documented disability and require accommodations, please contact the Disability Resource Center at (925) 424-1510.

CORE SERVICE 3: STUDENT EDUCATIONAL PLAN (SEP)

After completing your assessment, you will have the opportunity to schedule an educational planning session with a counselor to review your assessment results, to learn about your educational/career options and develop a Student Educational Plan (SEP) for your first year at LPC.

During your first semester of attendance, you are strongly encouraged to make an appointment to meet with a counselor to discuss your goals and develop a Student Educational Plan (SEP). The purpose of your SEP is to help plan the courses that are required to meet your educational goal(s). During your SEP appointment with a counselor, you will learn what courses you need, the overall time line to complete your goal, and the support services available to help your successfully achieve your goal(s). Visit the LPC homepage and search “Counseling” for counseling services offered, and available hours.

TRACK YOUR PROGRESS WITH DEGREEWORKS

LPC offers a web-based tool to help you keep track of your educational progress! DegreeWorks (DW) allows you as a student to view your Student Educational Plan and confirm what courses you have completed, as well as what courses remain, toward meeting your educational objective(s). DW matches your academic and course history, as well as your current course schedule, against the degree requirements as defined in the LPC College Catalog.* Thinking about adding a major, or changing your goal? DW also gives you the opportunity to explore “What If Scenarios,” to determine how your courses meet requirements for programs other than your current declared major. Please meet with a counselor for questions about your educational goal or to change your Student Educational Plan.

To access DegreeWorks, follow these steps:

1. Visit the LPC Home Page and log in to CLASS-Web.
2. Once logged in, navigate to the Student Service tab.
3. Scroll down to locate the DegreeWorks link.

**A degree audit created in DegreeWorks is not an official notification of completion of degree or certificate requirements.*

ACADEMIC PROGRAMS

Las Positas College is authorized by the Board of Governors of the California Community Colleges to confer the Associate in Arts for Transfer degree, Associate in Science for Transfer degree, Associate of Arts degree, Associate of Science degree, Certificate of Achievement, Certificate of Completion, and Certificate of Competency upon students who complete the necessary requirements. The Certificate of Accomplishment is not transcribed and provides industry-based professional development. The following is a listing of academic programs currently offered at Las Positas College.



DEGREEWORKS

ADVISE. PLAN. ACHIEVE.



Check degree requirements



Plan for future registrations



See completed courses + grades



Explore changing your major



View your cumulative GPA



Graduate from LPC!



LAS POSITAS
COLLEGE

Get ahead of your academic goals and take control of your education with DegreeWorks!

- Associate of Arts (AA)
- Associate of Science (AS)
- Associate in Arts for Transfer (AAT)
- Associate in Science for Transfer (AST)

- CA Certificate of Achievement
- CE Certificate of Accomplishment - not transcribed
- NY Certificate of Competency - noncredit
- NL Certificate of Completion - noncredit

* Occupational programs designed for job entry; some courses are transferable to 4-year institutions

Administration of Justice			
21st Century Policing			CA
Administration of Justice*	AA	AS-T	
Anthropology			
Anthropology		AA-T	
Apprenticeship Accounting Technician			
Accounting Technician			CA
Apprenticeship Information Security Analyst			
Information Security Analyst	AS		CA
Apprenticeship Marine Technology			
Marine Technology Boating 101			CA
Marine Technology Yachting 101			CA
Apprenticeship Reddaway Heavy Truck Driving			
Reddaway Heavy Truck Driving			CA
Reddaway Heavy Truck Driving Academy			CA
Art			
Art: Emphasis in Painting	AA		
Studio Arts		AA-T	
Art History			
Art History		AA-T	
Automotive Technology			
Automotive Advanced Smog Technician*			NL
Automotive Alternative Fuels/Hybrid Technology*	AS		CA
Automotive Basics*			NL
Automotive Chassis*			CA NL
Automotive Drivability*			CA
Automotive Electronics Technology*	AS		
Automotive Light Duty Diesel*	AS		CA
Automotive Master*	AS		CA
Automotive Mechanical*			CA NL
Automotive Smog*			NL
Automotive Smog Technician*	AS		CA
Automotive Summer Camp*			NL
Concepts of Automotive Body Systems*			NL
Concepts of Automotive Chassis*			NL
Concepts of Automotive Know How*			NL
Concepts of Automotive Mechanical*			NL
Concepts of Automotive Powertrain*			NL
Aviation			
Drone Photography, Mapping, and Piloting			NL
Biological Sciences			
Biology	AA	AS-T	
Biology: Allied Health	AA		
Biology UC Pathway	AS		CA
Computational Biology*	AA		CA
Business			
Accounting Technician*			CA
Bookkeeping*			CA
Business Administration	AA		
Business Administration 2.0		AS-T	
Business Entrepreneurship*	AA		CA
Business Workforce Proficiency*			CA
Customer Service*			NL
Retail Management (WAFC)*			CA
Small Business Management*			NL
Supervisory Management*			CA

Chemistry			
Chemistry	AS		
Chemistry Education	AS		
Communication Studies			
Communication Studies 2.0		AA-T	
Computer Information Systems			
Administrative Assistant*	AA		CA
Administrative Medical Assistant*			CA
Cloud Computing*			CA
Computer Applications Software*			CA
Computer Information Systems*	AA		
Computer Information Technologist*	AS		
Data Analytics*			CA
Project Management*			CA
Web Development*			CA
Computer Networking Technology			
Cybersecurity and Network Administration*	AS		
Cybersecurity Professional*			CA
IT Support Professional*			CA
Network Support Professional*			CA
Computer Science			
Artificial Intelligence*			CA
Computer Programming*			CA
Computer Programming for the Web*			CA
Computer Science	AS		
Management Information Systems*			CA
Red Hat Administration*			CA
Early Care and Education			
Associate Teacher*			CA
Child and Adolescent Development*		AA-T	
Early Childhood Development*	AA		CA
Early Childhood Education*		AS-T	
Early Childhood Intervention*	AA		
Early Childhood Intervention Assistant*			CA
Elementary Teacher Education*		AA-T	
Economics			
Economics		AA-T	
Emergency Medical Services			
Emergency Medical Responder*			CE
Emergency Medical Services EMT-Paramedic*	AS		CA
Emergency Medical Technologies*			CA
Engineering			
Civil/Mechanical Engineering	AS		CA
Electrical Engineering	AS		CA
Electrical Engineering UC Pathway	AS		CA
Engineering	AS		CA
Engineering Technology*	AS		CA
Mechanical Engineering UC Pathway	AS		CA
Software Engineering	AS		CA
English			
Creative Writing			CA
English	AA	AA-T	
English as a Second Language			
Advanced ESL Communication Studies*			NL
ESL College Grammar Pathway			NY
ESL College Reading and Writing Pathway			NY

Vocational ESL: Retail*				NL
Environmental Science				
Environmental Science	AS			
Environmental Studies				
Environmental Studies	AA			
Film Studies				
Film Studies	AA		CA	
Fire Service Technology				
Company Officer*			CA	
Fire Academy - Fire Suppression*			CA	
Fire Officer Leadership and Management*	AS			
Fire Prevention*			CA	
Fire Service Technology*	AS		CA	
Geography				
Geography		AA-T		
Geology				
Geology		AS-T	CA	
Geology Major			CA	
Global Studies				
Global Studies		AA-T		
Graphic Arts & Digital Media				
Digital Illustration*			CA	
Graphic Design*	AA		CA	
Print Design*			CA	
Web & Interaction Design*			CA	
Health				
Public Health Science		AS-T		
History				
History		AA-T		
Horticulture				
Horticulture*	AS			NL
Landscape Design*			CA	
Landscape Maintenance and Construction*			CA	
Nursery, Greenhouse, and Grower Operations*			CA	
Ornamental Horticulture*			CA	
Humanities				
Humanities	AA		CA	
Interior Design				
Interior Design*	AS		CA	
Journalism				
Journalism*		AA-T	CA	
Journalism and Media Studies	AA			
Kinesiology				
Athletic Training/Sports Medicine*			CA	
Fitness Trainer*			CA	
Kinesiology		AA-T		
Lesbian, Gay, Bisexual, Transgender, and Queer Studies				
Social Justice Studies: LGBTQ Studies		AA-T		
Liberal Arts and Sciences				
Arts and Humanities	AA			
Business	AA			
Computer Studies	AA			
Language Arts and Communication	AA			
Mathematics and Science	AA			
Social and Behavioral Sciences	AA			
Library Studies				
Basic Research Skills*				NL

Marketing				
Marketing*	AA		CA	
Retailing*			CA	
Mathematics				
College Mathematics Pathway				NY
College Mathematics Support				NY
Foundational Mathematics Pathway				NY
Math Jam Tutor Pathway				NL
Mathematics		AS-T		
Music				
Commercial Music: Music Business*			CA	
Commercial Music: Music Technology Fundamentals*			CA	
Commercial Music: Piano Teaching Fundamentals*			CA	
Commercial Music: Scoring for Film and Multimedia*			CA	
Commercial Music: Teaching Beginning Piano*			CA	
Commercial Music: Teaching Intermediate Piano*			CA	
Jazz Studies			CA	
Music	AA	AA-T		
Nutrition				
Nutrition and Dietetics		AS-T		
Occupational Safety and Health				
Occupational Safety and Health*	AS		CA	
Occupational Safety*			CA	
Philosophy				
Philosophy		AA-T		
Photography				
Photography*	AA		CA	
Physics				
Physics	AS			
Political Science				
Political Science		AA-T		
Psychology				
Psychology		AA-T		
Psychology-Counseling				
Social Work and Human Services*		AA-T		
Sociology				
Sociology		AA-T		
Spanish				
Spanish		AA-T	CA	
Theater Arts				
Acting*			CA	
Actors Conservatory*			CA	
Musical Theater			CA	
Technical Theater*			CA	
Theater Arts	AA	AA-T		
University Transfer				
CSU General Education Breadth			CA	
IGETC (Intersegmental General Education Curriculum)			CA	
Viticulture & Winery Technology				
Enology*	AS		CA	
Viticulture*	AS		CA	
Wine Hospitality*			CA	
Welding Technology				
Welding Technology*	AS		CA	
Women's Studies				
Social Justice Studies: Gender Studies		AA-T		

If you have any questions regarding programs of study, please be sure to see a counselor.



FREE GROCERY @ THE MINI MARKET!

**FREE FOOD, HYGIENE PRODUCTS,
CLEANING SUPPLIES,
DIAPERS/WIPES**

HOURS OF OPERATION

MONDAY - THURSDAY: 10:00 A.M. - 5:00 P.M.

FRIDAY: 10:00 A.M. - 4:00 P.M.

STUDENT LIFE WELCOME CENTER - 1643



*Scan me to
register!*

Spring 2024

Course Listings

Las Positas College will offer classes online, on-campus, and in hybrid or Hyflex modalities during Spring 2024.

FULL TERM Courses: Jan 16 - May 24

LATE START Courses: Jan 29 - May 17

FAST TRACK 1 (*1st 8 weeks*):..... Jan 16 - Mar 15

FAST TRACK 2 (*2nd 8 weeks*): Mar 18 - May 17

Please click on the QR code below, or visit

https://bw11.clpccd.cc.ca.us/clpccd/2023/03/sched_I.htm

to view the current class schedule online, and find information on student learning support resources, both virtual and on-campus.

Scan here to visit the
current **SPRING 2024**
class schedule online



DESCRIPTION OF SECTION TYPES

DAY & EVENING ("D0_" and "E0_" sections) (fully on-campus only)

This course is an on-campus class. Carefully note the day, time and building the course will meet in-person.

Psychology Counseling								
CRN	Subj	Crse	Sec	Units	Title		Campus	
		Start Date		End Date	Days	Times	Bldg	Room
33031	PCN	3	D01	3.00	Theories of Counseling: Intro		Las Positas College	
		Jan 18, 2022		May 27, 2022	MW	11:00am - 12:15pm	L1600	1641
Instructor(s): Staff - LPC, GENERAL								
<i>This is a day section that meets in-person at the Las Positas College campus.</i>								

ASYNCHRONOUS ("A0_" sections) (fully online only)

This course is an asynchronous online class. It does not have scheduled meeting times. Weekly assignments are completed independently by the established deadlines in the class. Materials are accessed through the Canvas learning management system.

Art - History								
CRN	Subj	Crse	Sec	Units	Title		Campus	
		Start Date		End Date	Days	Times	Bldg	Room
32542	ARHS	1	A01	3.00	Intro to Art History		Las Positas College	
		Jan 18, 2022		May 27, 2022			LTBA	ONLINE
Instructor(s): RENTERIA, SORAYA								
<i>This course is an asynchronous online class. It does not have scheduled meeting times. Weekly assignments are completed independently by the established deadlines in the class. Materials are accessed through the Canvas learning management system.</i>								

SYNCHRONOUS ("S0_" sections) (online only with specific meeting days/times)

This course is a synchronous online class in which instruction occurs remotely at a scheduled time. Carefully note the day and time the class will meet online. Materials and links to the virtual classroom, Zoom, are accessed through the Canvas learning management system.

MATH								
CRN	Subj	Crse	Sec	Units	Title		Campus	
		Start Date		End Date	Days	Times	Bldg	Room
31288	MATH	1	S01	5.00	Calculus I		Las Positas College	
		Jan 18, 2022		May 27, 2022	MWF	9:30 AM- 10:55 AM	LTBA	ONLINE
Instructor(s): MAJUMDAR, RUCHIRA								
<i>This course is a synchronous online class in which instruction occurs remotely at a scheduled time. Carefully note the day and time the class will meet online. Materials and links to the virtual classroom, Zoom, are accessed through the Canvas learning management system.</i>								

BOTH ("B0_" sections) (combination of Asynchronous and Synchronous online)

This class will meet live (synchronously) online via Zoom at the days and times listed. Other content will be delivered online through the Canvas learning management system (asynchronously).

HUMANITIES								
CRN	Subj	Crse	Sec	Units	Title		Campus	
		Start Date		End Date	Days	Times	Bldg	Room
31491	ENG	4	B01	3.00	Critical Thinking/Writing Lit		Las Positas College	
		Jan 18, 2022		May 27, 2022	M	8:00 AM- 9:15 AM	LTBA	ONLINE
		Jan 18, 2022		May 27, 2022			LTBA	ONLINE
Instructor(s): Staff - LPC, GENERAL								
<i>Class will meet live (synchronously) online via Zoom at the time listed. Other content will be delivered online through Canvas (asynchronously).</i>								

DESCRIPTION OF SECTION TYPES

HYBRID ("H0_" sections) (Asynchronous -or- Synchronous online, with in-person components)

This course meets both in-person and online. Carefully note the day, time and building the course will meet in-person. Other instruction is completed online. The instructor will provide more details through the Canvas learning management system at the start of the semester.

Humanities								
CRN	Subj	Crse	Sec	Units	Title		Campus	
		Start Date		End Date	Days	Times	Bldg	Room
33145	KIN	17	H01	4.00	Intro Athletic Training/Sports Med		Las Positas College	
		Jan 19, 2021		May 28, 2021			LTBA	ONLINE
		Jan 19, 2021		May 28, 2021	TTh	9:30 AM- 10:45 AM	L2500	PE104 ¹
Instructor(s): LE CARA, ANELA L								
<i>This course meets both in-person and online. Carefully note the day, time and building the course will meet in-person. Other instruction is completed online. The instructor will provide more details through the Canvas learning management system at the start of the semester.</i>								

¹On-campus courses will reflect a designated room number for meeting on campus.

HyFLEX ("HF_" sections) (on-campus -or- optional online)

This is a hybrid-flexible course, referred to as HyFlex. Students may choose to attend class on campus at the times, days, and building location noted, or they can participate online. To determine if the instructor allows synchronous online participation via Zoom and/or asynchronous online participation via Canvas, view the HyFlex Participation Options page at www.laspositascollege.edu/onlinelearning/hyflex_options.php.

ENGLISH								
CRN	Subj	Crse	Sec	Units	Title		Campus	
		Start Date		End Date	Days	Times	Bldg	Room
30207	ENG	7	HF1	3.00	Critical Thinking/Writing		Las Positas College	
		Jan 17, 2023		May 26, 2023	MW	9:30 AM- 10:45 AM	L2500	PE104 ¹
Instructor(s): KISHA QUESADA TURNER								
This is a HyFlex course. A student may choose to attend class on campus at the times, days, and building location noted or they can join the live class remotely through ConferZoom. Throughout the semester, students will have the flexibility to move between modalities. For more information on HyFlex classes, see laspositascollege.edu/onlinelearning/hyflex.php .								

FAST TRACK

This is an accelerated 8-week course. Please carefully note the start date of the course.

ENGLISH								
CRN	Subj	Crse	Sec	Units	Title		Campus	
		Start Date		End Date	Days	Times	Bldg	Room
30343	ENG	1A	A12	3.00	Critical Reading and Comp		Las Positas College	
		Mar 20, 2023		May 19, 2023			LTBA	ONLINE
Instructor(s): DURAN, LISA								
This is an accelerated 8-week course. Please carefully note the start date of the course. This course is an asynchronous online class. It does not have scheduled meeting times. Weekly assignments are completed independently by the established deadlines in the syllabus. Materials are accessed through the learning system Canvas.								

SPRING 2024 Course Listings

Explanation of Terms used in the Course Listings on CLASS-Web

SECTION NUMBERS

- DO_ = On-Campus Day
- EO_ = On-Campus Evening
- AO_ = Asynchronous (fully online)
- SO_ = Synchronous (online with specific meeting days/times)
- BO_ = Both (combination of Synchronous and Asynchronous online)
- HO_ = Hybrid (online with in-person component)
- HF_ = HyFLEX (on-campus -or- optional online)

- AP_ = Apprenticeship
- CO_ = Corequisite Paired Course
- CE_ = Credit by Exam
- FC_ = Federal Corrections
- FSA = College Foundation
- HS_ = High school (grant-funded)
- LC_ = ECD Learning Community
- MO_ = Math Jam
- PO_ = Puente Program
- ST_ = Alternate Instruction
- TO_ = Technical Math: Emporium Mode
- UO_ = Umoja Program
- VT_ = Veteran Program
- WLC = Weekend ECD Learning Community
- XO_ = Math Emporium Mode

MEETING DAYS

- M/Mon = Monday
- T/Tue = Tuesday
- W/Wed = Wednesday
- R/Th/Thu = Thursday
- F/Fri = Friday
- S/Sat = Saturday
- Daily = Monday thru Friday

ROOMS

Refer to campus map on page 87 for room and building locations.

(*) indicates a course is held off-campus

All registration notices, Financial Aid, and general College information will be sent to your ZONEmail Account. Check it regularly.

STAFF NOTATION

As courses are assigned to instructors, the updates will be posted on CLASS-Web.

SPRING 2024 TERM DATES

- Full-Term1/16 - 5/24
- Late Start.....1/29 - 5/17
- Fast Track 1 1/16 - 3/15
- Fast Track 2.....3/18 - 5/17

NOTE: Start and end dates for a course affect deadlines such as add, drop, and census. See **purple box below** for instructions on how to find these dates for each course.

UNITS

Indicates unit value of each course.

NON-CREDIT classes are noted in GREEN

- Courses are open to all students who meet the academic requirements.
- All course information is subject to change.
- Courses not meeting enrollment requirements may be cancelled.

Important Enrollment Information

Please pay close attention to course deadline dates

These dates may vary for some courses (such as Late Start and Fast Track). Complete the following steps to check the deadline dates to add a course, drop with NGR (no-grade-of-record), get a refund, pass/no pass and withdrawal:

How to Check for Add, Drop NGR, Refund, Pass/No Pass and Withdrawal deadlines:

1. Log into CLASS-Web
2. Select the "Student Services" tab
3. Click the "Registration" link
4. Click the "Check Class Deadlines" link
5. Enter the CRN

Courses, dates, and times are subject to change. Please check the college website at www.laspositascollege.edu for the most up-to-date information regarding Spring course offerings.

ADMINISTRATION OF JUSTICE

AJ 50 INTRO TO ADMIN OF JUSTICE 3.0 Units

History and philosophy of administration of justice in America; recapitulation of the system; identifying the various subsystems, role expectations, and their interrelationships; theories of crime, punishment, and rehabilitation; ethics, education and training for professionalism in the system.

AJ 55 INTRO TO CORRECTIONAL SCIENCE 3.0 Units

Aspects of modern correctional process as utilized in rehabilitation of adult and juvenile offenders. Emphasis on custody, rehabilitation and treatment programs as recognized by modern penology. Exploration of career opportunities.

AJ 60 CRIMINAL LAW 3.0 Units

Historical development, philosophy of law and constitutional provisions, definitions, classification of crime, and their application to the system of administration of justice; frequently used Penal and other code sections; case law, methodology, and concepts of law as a social force.

AJ 61 EVIDENCE 3.0 Units

Origin, development, philosophy and constitutional basis of evidence; constitutional and procedural considerations affecting arrest, search and seizure; kinds and degrees of evidence and rules governing admissibility; judicial decisions interpreting individual rights and case studies.

AJ 66 JUVENILE PROCEDURES 3.0 Units

This course is an examination of the origin, development, and organization of the juvenile justice system as it evolved in the U.S. justice system. The course explores the theories that focus on juvenile law, courts and processes, and the constitutional protections extended to juveniles in the U.S justice system.

Strongly Recommended: ENG 1A with a minimum grade of C

AJ 68 POLICE ETHICS AND LEADERSHIP 3.0 Units

This course will explore the ethical, legal and moral complexities of law enforcement in a democracy. From the initial application process and background investigation of a potential law enforcement recruit, to the working law enforcement officer, the course will examine society's need for organizational integrity and leadership in law enforcement agencies and the personal commitment to ethical behavior and individual leadership by law enforcement officers, both on the job and in their private lives.

AJ 70 COMMUNITY RELATIONS 3.0 Units

This course examines the complex, dynamic relationship between communities and the justice system in addressing crime and conflict with an emphasis on the challenges and prospects of administering justice within a diverse multicultural population. Topics may include the consensus and conflicting values in Culture, Religion, and Law.

AMERICAN SIGN LANGUAGE

ASL 1A AMERICAN SIGN LANGUAGE I 3.0 Units

Introduction to American Sign Language (ASL) including expressive and receptive sign, the manual alphabet, facial expression, and body gestures. Emphasis on conversational skills in functional situations, knowledge of Deaf culture and the Deaf community.

ASL 1B AMERICAN SIGN LANGUAGE II 3.0 Units

Continued development of American Sign Language (ASL) receptive/ expressive skills and knowledge learned in ASL 1A. Emphasis on conversational skills in functional situations, continued vocabulary and sentence structure expansion, and knowledge of Deaf culture and the Deaf community.

Prerequisite: ASL 1A with a minimum grade of C

ASL 2B AMERICAN SIGN LANGUAGE IV 3.0 Units

Further development of American Sign Language (ASL) receptive/ expressive skills and knowledge learned in ASL 2A. Emphasis on conversational skills in functional situations, continued expansion of vocabulary and knowledge of Deaf culture and the Deaf community.

Prerequisite: ASL 2A with a minimum grade of C

ANTHROPOLOGY

ANTR 1 BIOLOGICAL ANTHROPOLOGY 3.0 Units

This course introduces the concepts, methods of inquiry, and scientific explanations for biological evolution and their application to the human species. Issues and topics will include, but are not limited to, genetics, evolutionary theory, human variation and biocultural adaptations, comparative primate anatomy and behavior, and the fossil evidence for human evolution. The scientific method serves as foundation of the course.

Recommended Course Preparation: Eligibility for ENG 1A

ANTR 1L BIOLOGICAL ANTHROPOLOGY LAB 1.0 Units

This laboratory course is offered as a supplement to Introduction to Biological Anthropology either taken concurrently or in a subsequent term. Laboratory exercises are designed to introduce students to the scientific method and explore genetics, human variation, human and non-human primate anatomy and behavior, the primate/hominin fossil record and other resources to investigate processes that affect human evolution.

Prerequisite: ANTR 1 with a minimum grade of C (May be taken concurrently)

Recommended Course Preparation: Eligibility for ENG 1A

ANTR 2 INTRODUCTION TO ARCHAEOLOGY 3.0 Units

This course is an introduction to the study of concepts, theories, data and models of anthropological archaeology that contribute to our knowledge of the human past. The course includes a discussion of the nature of scientific inquiry; the history and interdisciplinary nature of archaeological research; dating techniques; methods of survey, excavation, analysis, and interpretation; cultural resource management; professional ethics; and selected cultural sequences.

Recommended Course Preparation: Eligibility for ENG 1A

ANTR 3 CULTURAL ANTHROPOLOGY 3.0 Units

This course explores how anthropologists study and compare human culture. Cultural anthropologists seek to understand the broad arc of human experience focusing on a set of central issues: how people around the world make their living (subsistence patterns); how they organize themselves socially, politically and economically; how they communicate; how they relate to each other through family and kinship ties; what they believe about the world (belief systems); how they express themselves creatively (expressive culture); how they make distinctions among themselves such as through applying gender, racial and ethnic identity labels; how they have shaped and been shaped by social inequalities such as colonialism; and how they navigate culture change and processes of globalization that affect us all. Ethnographic case studies highlight these similarities and differences, and introduce students to how

anthropologists do their work, employ professional anthropological research ethics and apply their perspectives and skills to understand humans around the globe.

Recommended Course Preparation: Eligibility for ENG 1A.

ANTR 4 LANGUAGE AND CULTURE 3.0 Units

This introductory course serves as a foundation for understanding language from an anthropological perspective, addressing such core questions as how, what, when, where, why and with whom we communicate. This course surveys three core areas in linguistic anthropology --structural linguistics: phonetics, phonology, morphology and syntax, as well as the biocultural basis of language; historical linguistics: origins and evolution/change, dialects, and language families; and sociocultural linguistics: language acquisition in cultural context, emphasizing the relationship between language and culture, and issues of language conservation and loss.

Recommended Course Preparation: Eligibility for ENG 1A

ANTR 12 MAGIC/RELIGION/WITCHCRAFT/HEAL 3.0 Units

Cross-cultural perspectives on spirituality, religious practice, myth, ancestor beliefs, witchcraft and the variety of religious rituals and practitioners found in the cultures of the world. Examination of the cosmologies of different cultures through the anthropological perspective. Emphasis is placed on how knowledge of the religious practices and beliefs of others can help us to understand the multicultural world in which we live. Comparison of the ways in which diverse cultures confront the large and fundamental questions of existence: those dealing with the meaning life, birth and death, and with the relationship of humans to each other and to their universe.

Recommended Course Preparation: Eligibility for ENG 1A/1AEX

ANTR 13 INTRO TO FORENSIC ANTHROPOLOGY 3.0 Units

Introductory course in the application of physical anthropology to the medico-legal process with an emphasis on the identification of human skeletal remains. Includes basic human osteology and odontology , assessment of age at time of death, sex, ancestry, trauma analysis, pathology, and general physical characteristics including height and weight based upon minimal skeletal remains. Estimation of time since death, crime scene analysis, animal scavenging, and identification procedures.

Recommended Course Preparation: Eligibility for ENG 1A

APPRENTICESHIP MARINE TECH

APMT 52 BOATWORKS 101 YACHT PROPULSION 4.0 Units

This course is an introduction to yacht propulsion systems, including theory, routine service, and maintenance. Enrollment Limitation: Admission to this course is limited to apprentices registered with the state of California Department of Apprenticeship Standards.

Students must first be accepted into a registered Boatworks 101 apprenticeship.

APMT 53 BOATWORKS101 CRAFTSMANSHIP LAB 0.5 Units

This course is a lab-only class that will allow the student to showcase and be evaluated on their craftsmanship skills. Enrollment Limitation: Admission to this course is limited to apprentices registered with the state of California Department of Apprenticeship Standards.

Students must first be accepted into a registered Boatworks 101 apprenticeship.

APMT 94 OCCUPATIONAL WORK EXPERIENCE 1.0-8.0 Units

College supervised on-the-job training. Apprenticeship work experience in an occupation related to student's apprenticeship program. Cooperative effort of the work supervisor, student, Joint

Apprenticeship Training Council (JATC) or Program Sponsor, and instructor to achieve work-based learning objectives. Student must be enrolled in an apprenticeship program. Each Unit of Credit requires 75 hours of paid work experience. Students can earn 1 to 8 units per semester for a maximum of 16 units of Cooperative Work Experience, which includes General Work Experience and Occupational Work Experience/Internship. Enrollment Limitation: Admission to this course is limited to apprentices registered with the state of California Department of Apprenticeship Standards.

Students must first be accepted into a registered Boatworks 101 apprenticeship.

ART - HISTORY

ARHS 1 INTRO TO ART HISTORY 3.0 Units

Architecture, sculpture, painting, photography and design in relation to human inventiveness in providing for material and aesthetic needs. This course provides a general introduction to art that offers a look at works of art through the study of theory, terminology, themes, design principles, media, techniques, with an introduction to art that offers a look at works of art through the study of theory, terminology, themes, design principles, media, techniques, with an introduction to the visual arts across time and diverse cultures.

Recommended Course Preparation: Eligibility for ENG 1A

STUDENTS CAN TAKE ART HISTORY CLASSES IN ANY ORDER

ARHS 2 ART OF THE ANCIENT AMERICAS 3.0 Units

Survey of visual culture within the historical context of select ancient civilizations in Mexico, Central American, and South America up to European contact.

Recommended Course Preparation: ENG 1A with a minimum grade of C

ARHS 4 WESTERN ART HISTORY- ANCIENT 3.0 Units

History of Western art from prehistoric times through Egyptian, Mesopotamian, Aegean, Greek, Etruscan, Roman, Early Christian, Byzantine, Medieval, Romanesque, and Gothic civilizations.

Recommended Course Preparation: Eligibility for ENG 1A

STUDENTS CAN TAKE ART HISTORY CLASSES IN ANY ORDER

ARHS 5 WESTERN ART HIST- RENAISSANCE 3.0 Units

History of Western art from Early Renaissance, High Renaissance, Mannerism, Baroque, Neoclassicism, Romanticism, Realism, Impressionism, Post-Impressionism, 20th Century developments of American art.

Recommended Course Preparation: Eligibility for ENG 1A

STUDENTS CAN TAKE ART HISTORY CLASSES IN ANY ORDER

ARHS 7 MODERN ART HISTORY 3.0 Units

Presents an overview of the art movements, artists and issues of Modernism to Contemporary art. This includes art from the mid-nineteenth century, through the twentieth century and contemporary art. Incorporates the social, political, and aesthetic context of the time.

Recommended Course Preparation: ENG 1A with a minimum grade of C

STUDENTS CAN TAKE ART HISTORY CLASSES IN ANY ORDER.

Scan here to visit the current Spring 2024 class schedule online



ART

ARTS 2A INTRODUCTION TO DRAWING 3.0 Units

Introduction to principles, elements, and practices of drawing, employing a wide range of subject matter and drawing media. Focus on perceptually based drawing, observational skills, technical abilities, and creative responses to materials and subject matter.

Estimated cost of supplies \$100

ARTS 3A FIGURE AND COMPOSITION I 3.0 Units

Introduction to drawing the human figure from observation using a wide variety of drawing media and techniques. Topics include an introduction to human anatomy and the historical and contemporary roles of figure drawing in the visual arts. Students in this course will learn both descriptive and interpretive approaches to drawing the figure.

Recommended Course Preparation: ARTS 2A with a minimum grade of C

ARTS 3B FIGURE AND COMPOSITION II 3.0 Units

Development of knowledge and skills introduced in Arts 3A, with an emphasis on composition, color, and drawing the human figure from observation using a wide variety of drawing media and techniques. Topics include human anatomy and the historical and contemporary roles of figure drawing in the visual arts. Students in this course will learn both descriptive and interpretive approaches to drawing the figure.

Prerequisite: ARTS 3A with a minimum grade of C

Recommended Course Preparation: ARTS 2A with a minimum grade of C

ARTS 3C FIGURE AND COMPOSITION III 3.0 Units

Advanced application of knowledge and skills introduced in Arts 3B, with emphasis on composition and drawing the human figure from observation using a wide variety of drawing media and techniques. Topics include human anatomy and the historical and contemporary roles of figure drawing in the visual arts. Students in this course will start to utilize personal approaches and media to drawing the figure.

Prerequisite: ARTS 3B with a minimum grade of C

Recommended Course Preparation: ARTS 2A with a minimum grade of C

ARTS 3D FIGURE AND COMPOSITION IV 3.0 Units

Advanced application of knowledge and skills introduced in Arts 3C with further development of personal style. Topics include human anatomy and the historical and contemporary roles of figure drawing in the visual arts. Students in this course will learn both descriptive and interpretive approaches to drawing the figure.

Prerequisite: ARTS 3C with a minimum grade of C

Recommended Course Preparation: ARTS 2A with a minimum grade of C

ARTS 7A INTRO TO WATERCOLOR PAINTING 3.0 Units

Introduction to principles, elements, and practices of watercolor painting. Focus on exploration of painting materials, perceptual skills and color theory, paint mixing and technique, as well as creative responses to materials and subject matter.

Recommended Course Preparation: ARTS 2A with a minimum grade of C

ARTS 7B WATERCOLOR PAINTING 3.0 Units

Development of knowledge and skills introduced in Arts 7A with an emphasis on experimenting with the watercolor medium, perceptual skills and color theory, paint mixing and technique, as well as creative responses to materials and subject matter.

Prerequisite: ARTS 7A with a minimum grade of C

Recommended Course Preparation: ARTS 2A with a minimum grade of C

ARTS 7C ADVANCED WATERCOLOR PAINTING I 3.0 Units

Development of knowledge and skills introduced in 7B directed towards individual needs with an emphasis on individual expression.

Prerequisite: ARTS 7B with a minimum grade of C

Recommended Course Preparation: ARTS 2A with a minimum grade of C

ARTS 7D ADVANCE WATERCOLOR PAINTING II 3.0 Units

Advanced projects in watercolor painting with emphasis on demonstrating functional competence and an intellectual understanding of personal ideas. Further development of knowledge and skills introduced in 7C directed towards individualized needs.

Prerequisite: ARTS 7C with a minimum grade of C

Recommended Course Preparation: ARTS 2A with a minimum grade of C

ARTS 12A OIL/ACRYLIC PAINTING: BEGIN I 3.0 Units

Introduction to painting using oil or acrylic paints. Students will apply the principles and elements of design, in addition to color theory, to their own paintings. Students will make studies from observation, study works by the masters, and learn to express their own ideas through painting.

Recommended Course Preparation: ARTS 2A with a minimum grade of C

Estimated cost of supplies: \$200-\$300

ARTS 12B OIL/ACRYLIC PAINTING: BEGIN II 3.0 Units

Second level course in painting using oil or acrylic paints. With the skills and knowledge gained in ARTS 12A, students will apply the principles and elements of design, in addition to color theory, to their own paintings. Students will make intermediate level studies from observation, study works by the masters, and learn to express their own ideas through painting.

Prerequisite: ARTS 12A with a minimum grade of C

Recommended Course Preparation: ARTS 2A with a minimum grade of C

ARTS 12C OIL/ACRYLIC PAINTING: ADV I 3.0 Units

Advanced projects in oil or acrylic painting with an emphasis on individual creative work and development of personal ideas and style.

Prerequisite: ARTS 12B with a minimum grade of C

Recommended Course Preparation: ARTS 2A with a minimum grade of C

ARTS 12D OIL/ACRYLIC PAINTING: ADV II 3.0 Units

Advanced projects in oil or acrylic painting with emphasis on developing ideas, skills, and knowledge. Students hone their painting through practice and critique; this course requires self direction.

Prerequisite: ARTS 12C with a minimum grade of C

Recommended Course Preparation: ARTS 2A with a minimum grade of C

ARTS 23 2-D DESIGN 3.0 Units

Introduction to the concepts, applications, and historical references related to 2-dimensional art and composition. Topics include the basic principles and elements of design. In this course, students will develop their visual vocabulary for creative visual expression through lectures and problem solving studio projects. Students explore aspects of 2-D Design through visual art assignments.

ARTS 24 3-D DESIGN 3.0 Units

Introduction to the concepts, applications, and historical references related to 3-dimensional design and spatial composition, including the study of the elements and organizing principles of design as they apply to 3-dimensional space and form. Development of a visual vocabulary for creative expression through lecture presentations and use of appropriate materials for 3-dimensional studio projects.

ARTS 26 COLOR THEORY 3.0 Units

A basic-level course highlighting color as an element for communication and expression in all visual fields. Covers key color systems and their relevance to graphic and other visual arts and creative and technical aspects of color. Students who have completed, or are enrolled in, GDDM 51 may not receive credit.

ASTRONOMY

ASTR 30L INTRODUCTION TO ASTRONOMY LAB 1.0 Units

Introduction to laboratory principles and techniques in astronomy. Includes: observational techniques such as naked eye, binocular, and telescopic identification of stars, planets, constellations, and deep sky objects; telescope operation and imaging; spectroscopy, motions of the sun, moon and planets.

Prerequisite: ASTR 31 or ASTR 32 with a minimum grade of C (May be taken concurrently)

ASTR 31 INTRO TO ASTRONOMY: SOLAR SYS. 3.0 Units

Introduction to history and physical principles of astronomy, focusing on our Solar System. Includes: constellations; distance scales; historical development of astronomy; gravitation; motion of the Earth, Moon, and Planets; astronomical tools; formation and evolution of the solar system; physical properties, atmosphere, and evolution of the Earth, Moon, and planets within the solar system; asteroids, comets, and other small bodies; discovery of extra- solar planets; possibilities for life beyond Earth. Designed for non-majors in mathematics or a physical science.

A companion science lab, Astronomy 30L, is also available.

ASTR 32 INTRO: STARS AND THE UNIVERSE 3.0 Units

Introduction to the study of stars, galaxies, and cosmology. Includes the nature of light and matter, telescopes, spectroscopy, stellar formation and evolution, galaxies, quasars, and cosmology. Designed for non-majors in mathematics or a physical science.

A companion science lab, Astronomy 30L, is also available.

AUTOMOTIVE TECHNOLOGY

AUTO A4 SUSPENSION AND STEERING 4.0 Units

Diagnosis, evaluation, testing, adjustment, alignment and repair of steering and suspension systems. Including all common automotive steering and suspension systems both car and truck. Future systems will also be covered. Students are strongly recommended to enroll in Automotive Lab concurrently.

Prerequisite: AUTO INTR with a minimum grade of C (May be taken concurrently)

AUTO A5 BRAKES 4.0 Units

Diagnosis, evaluation, inspection, adjustment, and repair of braking, antilock braking systems, traction control and related devices. Class will involve California State law regarding brake and safety inspections. Includes the material on the California Brake Adjuster's Licensing Examination.

Prerequisite: AUTO INTR with a minimum grade of C (May be taken concurrently)

Students are strongly recommended to enroll in Automotive Lab concurrently.

AUTO A6 ELECTRICAL/ ELECTRONIC SYSTEMS 5.0 Units

Automotive electrical/electronic systems, including electrical circuits, ohms law, battery, starting, charging, ignition, fuel,

accessories, brakes, chassis, suspension, steering, HVAC and wiring systems. Emphasis on diagnosis of electrical troubles, assembly, and repair of components and diagnostic equipment usage.

Prerequisite: AUTO INTR with a minimum grade of C (May be taken concurrently)

Students are strongly recommended to enroll in Automotive Lab concurrently.

AUTO INTL AUTO SERVICE AND INTRO LAB 2.0 Units

This is the Lab section that can only be taken if you are also taking INTZ. Bumper-to-Bumper Automotive Knowledge. Starting with hazardous waste handling, tool identification, maintenance and lubrication, moving into engine mechanical, emissions controls, suspension systems, air conditioning, airbags and safety, transmissions, axles, and finishing off with the future of the automotive industry. This is an introductory class for people who want to know more about their vehicle or who are planning an automotive career.

Corequisite: AUTO INTZ (This is the lab section and must be taken at the same time)

AUTO INTZ AUTO SERVICE AND INTRO LECTURE 2.0 Units

This class is lecture only, AUTO INTL must also be taken concurrently. Bumper-to-Bumper Automotive Knowledge. Starting with hazardous waste handling, tool identification, maintenance, and lubrication, moving into engine mechanical, emissions controls, suspension systems, air conditioning, airbags and safety, transmissions, axles, and finishing off with the future of the automotive industry. This is an introductory class for people who want to know more about their vehicle or who are planning an automotive career.

Corequisite: AUTO INTL

AUTO LABC LAB SPECIALIZED BENCH WORK 2.0 Units

Automotive Lab Specialized Bench Work is an open laboratory class for automotive students. This class is for students desiring to expand their hands-on experience using shop equipment. This class specializes in rebuilding automotive parts. The instructor will provide technical and supervisory support to guide students in the completion of their self-initiated projects. Service information via computer service manuals will be available for students to use for vehicle information and research. Class is recommended for second year students only.

Prerequisite: AUTO INTR or NAUT INTR or AUTO INTL and AUTO INTZ with a minimum grade of C. May be taken concurrently

AUTO LABD LAB SPECIALIZED ELECTRONIC WK 2.0 Units

Automotive Lab Specialized Electronic Work is an open laboratory class for automotive students. This class is for students desiring to expand their hands-on experience using shop equipment. This class specializes in electronics work. This includes accessories, EV, hybrid, and aftermarket electrical. The instructor will provide technical and supervisory support to guide students in the completion of their self-initiated projects. Service information via computer service manuals will be available for students to use for vehicle information and research.

Prerequisite: AUTO INTR or NAUT INTR or AUTO INTL and AUTO INTZ with a minimum grade of C. May be taken concurrently.

AUTO L1L2 SMOG LEVEL ONE AND LEVEL TWO 5.5 Units

This course includes classes/modules the State of California's requires for a student/automotive technician to be prepared to take

Scan here to visit the current Spring 2024 class schedule online



their Smog License Test. This class will include Level One and Level Two smog training only. At the end of the class students may or may not qualify for either EI or EO smog license. See www.smogcheck.ca.gov for more information.

AUTO LABA AUTOMOTIVE LAB 2.0 Units

Automotive Lab is an open laboratory class for basic automotive students. This class is for students desiring to expand their hands-on experience using their own vehicle. Instructor will provide technical and supervisory support to guide students in completion of their self initiated projects. Service information via computer service manuals will be available for students to use for vehicle information and research.

Prerequisite: AUTO INTR or NAUT INTR with a minimum grade of C (May be taken concurrently) or AUTO INTL and AUTO INTZ with a minimum grade of C (May be taken concurrently)

AUTO LABB AUTOMOTIVE LAB ADVANCED 2.0 Units

Automotive Lab Advanced is an open laboratory class for advanced automotive students. This class is for students desiring to expand their hands-on experience using their own vehicle. Instructor will provide technical and supervisory support to guide students in completion of their self initiated projects. Students are expected to help others in class and be able to work without guidance. Service information via computer service manuals will be available for students to use for vehicle information and research. Class is recommended for second year students only.

Prerequisite: AUTO LABA or NAUT LABA with a minimum grade of C and AUTO INTR or NAUT INTR with a minimum grade of C or AUTO INTL and AUTO INTZ with a minimum grade of C (May be taken concurrently) or NAUT INTR with a minimum grade of C

BIOLOGICAL SCIENCES

BIO 1A GENERAL BOTANY 5.0 Units

Diversity, structure and function of plant, fungal, and protistan phyla. Topics include development, morphology, physiology and systematics. Principles of population and community ecology and ecosystem interactions.

Prerequisite: Intermediate Algebra or a higher level of mathematics.

Recommended Course Preparation: BIO 30 with a minimum grade of C

BIO 1B GENERAL ZOOLOGY 5.0 Units

Major groups of animal phyla and heterotrophic unicellular eukaryotes. Topics include comparative structure and function, development, ecology, taxonomy, phylogeny, evolution, and behavior. Designed for majors in biological sciences and related fields. (Note: Formerly ZOOL 1.)

Prerequisite: Intermediate Algebra or a higher level of mathematics.

Recommended Course Preparation: BIO 30 with a minimum grade of C

BIO 1C CELL AND MOLECULAR BIOLOGY 5.0 Units

Principles of cell and molecular biology. Includes biochemistry, cell structure and function, cell homeostasis, cell metabolism, cell reproduction, cell communication, genetics, molecular biology, biotechnology, and evolution. Emphasis on scientific inquiry and experimental design.

Prerequisite: BIO 1A or BIO 1B, and CHEM 1A with a minimum grade of C Eligibility for college-level composition (ENG 1A, ENG 1AEX, or ESL 1A) as determined by college assessment or other appropriate method

BIO 2A BIOINFORMATICS 4.0 Units

Principles of Bioinformatics. Project-based course which will analyze complex biological data. The course introduces students to the tools used for computational exercises relevant to current

biotechnologies and computational biology. Although BIO 30 can be taken as a prerequisite for BIO 2A, BIO 1C is required for the Computational Biology degree or certificate.

Prerequisite: BIO 30 or BIO 1C or CS 7 or CS 1 with a minimum grade of C

BIO 7A HUMAN ANATOMY 5.0 Units

Structural organization of the human body: gross and microscopic structure of the integumentary, skeletal, muscular, nervous, sensory, endocrine, cardiovascular, lymphatic, respiratory, digestive, excretory, and reproductive systems, from cellular to organ system levels of organization. This course is primarily intended for nursing, allied health, kinesiology, and other health related majors.

Prerequisite: BIO 30 or BIO 1B with a minimum grade of C and BIO 1C with a minimum grade of C. Eligibility for college-level composition (ENG 1A, ENG 1AEX, or ESL 1A) as determined by college assessment or other appropriate method. Eligibility for college-level mathematics as determined by college assessment or other appropriate method.

BIO 7B HUMAN PHYSIOLOGY 5.0 Units

Function and regulation of the human body. This course examines general, cellular, and molecular interactions that integrate the organ systems to maintain homeostasis. Human responses and computer simulations are used to collect and analyze data. Designed for nursing, physical and occupational therapy, and other health sciences majors.

Prerequisite: BIO 7A, BIO 30 or BIO 1B with a minimum grade of C and CHEM 1A or CHEM 30A or CHEM 31 with a minimum grade of C

Recommended Course Preparation: CHEM 30B with a minimum grade of C. Eligibility for college-level composition (ENG 1A, ENG 1AEX, or ESL 1A) as determined by college assessment or other appropriate method. Eligibility for college-level mathematics (MATH 1, 2, 3, 5, 7, 10, 27, 30, 33, 34, 39, 40, 47) as determined by college assessment or other appropriate method.

BIO 7C MICROBIOLOGY 5.0 Units

This course focuses on viruses, bacteria, fungi, protozoans, and helminths, with an emphasis on their relationship to humans. Cultivation, control, metabolism, body's defense against disease, microbial genetics, laboratory tests, and contemporary diseases are discussed. Methods used in the laboratory include standard bacteriological techniques (culturing, staining, biochemical testing, sensitivity testing etc.) as well as some molecular and immunological techniques, such as PCR and ELISA. Laboratory work also includes identification of unknowns, and/or independent research projects.

Prerequisite: BIO 30 or BIO 1B with a minimum grade of C and BIO 1C with a minimum grade of C. CHEM 1A or CHEM 30A or CHEM 31 with a minimum grade of C.

Recommended Course Preparation: BIO 7A with a minimum grade of C. Eligibility for college-level composition (ENG 1A, ENG 1AEX, or ESL 1A) as determined by college assessment or other appropriate method. Eligibility for college-level mathematics (MATH 1, 2, 3, 5, 7, 10, 27, 30, 33, 34, 39, 40, 47) as determined by college assessment or other appropriate method.

BIO 10 INTRO TO THE SCIENCE OF BIOL 4.0 Units

This course focuses on basic principles of biology, including scientific investigation and the study of the nature of living things. Focus is on student understanding of evolution and the unity and diversity of life from the molecular level to ecosystems and biosphere. Designed for non-majors in biology and biomedical sciences.

BIO 20 CONTEMPORARY HUMAN BIOLOGY 3.0 Units

A study of the Human organism, beginning at the cellular level, emphasizing organ systems, and also including topics of genetics and biotechnology. (Note: Formerly BIOL 20.)

BIO 30 INTRO TO COLLEGE BIOLOGY 4.0 Units

Basic principles of biology. Cell structure and function, cell division,

cell metabolism, reproduction, genetics, taxonomy, origin of life, and evolution. Laboratory emphasis on developing various laboratory skills, using the metric system, collecting data, graphing, interpreting data, and preparing for and taking laboratory exams. Designed to prepare the necessary concepts and laboratory skills and experience that are needed to succeed in more advanced courses in biology.

BIO 40 HUMANS AND THE ENVIRONMENT 3.0 Units

Introduction to environmental issues from a scientific perspective, focusing on physical, chemical, and biological processes within the Earth system, the interaction between humans and these processes, and the role of science in finding sustainable solutions. Topics include ecological principles, biodiversity, climate change, sustainability, renewable and non-renewable energy, water resources, air and water pollution, and solid waste management.

Recommended Course Preparation: Eligibility for ENG 1A

BIO 50 ANATOMY AND PHYSIOLOGY 4.0 Units

Structure and function of the human body is studied. Emphasis on human anatomy and physiological principles at the cellular and systemic level. Designed primarily for majors in paramedic and medical assisting programs and pre-medical students who wish to explore the realm of anatomy and physiology.

BIO 70 FIELD BIOLOGY 3.0 Units

A hands-on course in field biology. Students will learn basic concepts about ecology and environmental science through outdoor activities and exploration of a variety of ecosystems. The goals are to gain experience and develop skills in the following areas: identification of plants and animals, first-hand knowledge of a wide array of organism life histories, quantitative field research techniques and procedures applicable to plants and animals, and methods of recording data and observations. Field trips to local and regional habitats focus on seasonally relevant events, processes, and appropriate methodologies to study these communities.

BUSINESS

BUSN 1A FINANCIAL ACCOUNTING 4.0 Units

A study of accounting as an information system; examining why it's important, and how it's used by investors and creditors to make decisions. Includes the recording and reporting of business transactions with a focus on the accounting cycle, the application of generally accepted accounting principles and comparing it to international financial reporting standards, preparation and analysis of the classified financial statements for merchandising and service companies. Also includes issues related to recording and valuation of assets, liabilities, equities and cashflow, recognition of revenues, expenses using effective internal controls and ethical standards.

BUSN 1B MANAGERIAL ACCOUNTING 4.0 Units

A study of the use and reporting of accounting data for managerial planning, cost control, and decision making purposes. Includes broad coverage of concepts, structures, classifications, and behaviors of costs. Topics include; cost systems, job costing, process costing, activity based costing, relationship between cost, volume and profitability, relevant range, standard costing, profit planning and budgeting, static and flexible budgeting, responsibility accounting and segment reporting, absorption and variable costing and capital expenditure decisions.

Prerequisite: BUSN 1A with a minimum grade of C

BUSN 18 BUSINESS LAW 4.0 Units

A study of the legal environment of business. Covering laws

and regulations impacting business transactions. Introduction to the legal process. Topics include sources of legal concepts and ethics, torts, contracts, Uniform Commercial Code (UCC), warranties, product liability, consumer financial transactions, environmental, competition, agency, employment and labor, business organizations, and judicial and administrative processes.

Recommended Course Preparation: BUSN 40, ENG 1A or ENG 1AEX or ESL 1A with a minimum grade of C

BUSN 30 BUSINESS ETHICS AND SOCIETY 3.0 Units

A survey of the past and current behavior of business in American society. Examines the ethical, political and social issues confronting organizations and the organizations' responsibilities and obligations in responding to them. Discusses the responsibility of business toward customers, employees, stockholders, competitors, suppliers, government and the community at large.

Recommended Course Preparation: BUSN 40 with a minimum grade of C and Eligibility for ENG 1A

BUSN 33 PERSONAL FINANCIAL MANAGEMENT 3.0 Units

Designed to provide students with the practical, hands-on means of successfully managing their personal finances and of becoming financially empowered upon course completion. Among other topics, the course will cover the basics of credit management, assessing insurance needs, budgeting, personal financial statement preparation, investment and savings accounts, management of taxes, retirement accounts, will preparation and estate planning.

BUSN 40 INTRODUCTION TO BUSINESS 3.0 Units

A multidisciplinary examination and introduction to business operations within the U.S. and internationally. Provides an overview of global economic systems, business formations, business ethics and laws, general accounting practices and financing, facility location and layout, production, organizational structures and management functions. Fundamentals of risk management, marketing, human resources, and employee motivation are covered. Demonstrates how culture, society, and external business environments impact a business' ability to achieve its organizational goals.

Recommended Course Preparation: Eligibility for college-level composition (ENG 1A, ENG 1AEX, or ESL 1A) as determined by college assessment or other appropriate method.

BUSN 48 HUMAN RELATIONS IN ORG. 3.0 Units

An introduction to the interpersonal skills needed in today's workplace with a focus on effective communication, decision making, cross cultural relations, diversity, resolving conflict, managing change, group dynamics, and ethical behavior.

BUSN 51 ACCOUNTING FOR SMALL BUSINESS 3.0 Units

Basic accounting skills for managers and entrepreneurs that provide a foundation in financial reporting and analysis, payroll taxes, and internal controls. The course includes practical application of accounting theory to the accounting cycles for service and merchandising businesses, including bookkeeping practices, common debit and credit procedures, books of original entry, working papers, adjusting and closing entries, income statement, of owner's equity, balance sheet, cash, payroll, and special journals.

BUSN 52 BUSINESS COMMUNICATIONS 3.0 Units

This practical course supports career success by covering principles, strategies, and applications of effective business communications.

Scan here to visit the current Spring 2024 class schedule online



The course emphasizes critical thinking, problem solving, and ethical practices. Focus is placed on cultural dimensions of communication, listening skills, nonverbal communication, the writing process, social media, professionalism, teamwork, meeting management, presentation skills, and employment communication, including job interviewing and résumé writing.

Recommended Course Preparation: ENG 1A or ENG 1AEX with a minimum grade of C

BUSN 55 BUSINESS MATHEMATICS 3.0 Units

This course focuses on learning computations for typical business transactions including; simple interest, compound interest, installment sales, trade and cash discounts, mark-on percents, pricing, discounting notes and drafts, depreciation, taxes, insurance, statistics, stocks and bonds, and distribution of ownership and profits.

BUSN 56 INTRODUCTION TO MANAGEMENT 3.0 Units

Introduction to the application of tools, principles and concepts in business management. Emphasis will be on planning, organizing, leading, and controlling. Additional topics will include decision-making, employee motivation, team work, and current trends.

Recommended Course Preparation: Eligibility for college-level composition (ENG 1A, ENG 1AEX, or ESL 1A) as determined by college assessment or other appropriate method.

BUSN 58 SMALL BUSINESS MANAGEMENT 3.0 Units

Fundamentals of starting, operating and growing a successful small business enterprise. Emphasis on all endeavors: self-employment; freelancing; brick and mortar, pop-up and Internet retailing; technical and professional services; and franchising. Focus on achieving optimum benefits from limited resources; financing strategies; marketing options; legal, ethical, and regulatory issues encountered by all start-ups.

Recommended Course Preparation: BUSN 1A with a minimum grade of C

BUSN 61 QUICKBOOKS ACCOUNTING 2.0 Units

Introduction to the use of QuickBooks accounting software to process transactions related to a service and merchandise company. Specific topics include using company files, sales and receivables, payables and purchases bank and credit card reconciliations end of period transactions and payroll. Transactions include journalizing, adjusting entries, closing entries, bank reconciliation and preparing financial statements.

Recommended Course Preparation: BUSN 1A or BUSN 51 with a minimum grade of C

BUSN 87 ORGANIZATIONAL MGT LEADERSHIP 3.0 Units

This course examines the special case of detailed planning and implementation of management decisions in strategic business units. Attention is focused on three areas: developing action plans and implementation strategies, developing awareness of the contingencies to be considered in taking strategic actions, and investigating how different academic disciplines interpret the leadership phenomenon. This course highlights key criteria used in assessing the viability of an organizational action plan, and the role of leadership in managing constructive change processes.

Recommended Course Preparation: BUSN 40 with a minimum grade of C

CHEMISTRY

CHEM 1A GENERAL COLLEGE CHEMISTRY I 5.0 Units

Introduction to atomic structure, bonding, stoichiometry, thermochemistry, gases, matter and energy, oxidation-reduction, chemical equations, liquids and solids, solutions, chemical

energetics and equilibrium. Laboratory includes both quantitative and qualitative experiments.

Chabot Prerequisite: MTH 55 or MTH 55B CHEM 31 or skill level demonstrated through the Chemistry Placement Process.

LPC Prerequisites: CHEM 31 with a grade of C. The CHEM 31 prerequisite can be fulfilled by demonstrating the appropriate skill level in the Chemistry Placement Process. Intermediate Algebra or a higher level of mathematics.

CHEM 1B GENERAL COLLEGE CHEMISTRY II 5.0 Units

Continuation of Chemistry 1A. Includes chemical energetics and equilibria, solutions and ionic equilibria, acid-base chemistry, electrochemistry, coordination chemistry, kinetics, nuclear chemistry, organic chemistry, and the chemistry of family groups of the periodic table. Laboratory emphasizes quantitative techniques, including instrumentation, and qualitative analysis.

Prerequisite: Chemistry 1A with a minimum grade of C

CHEM 12B ORGANIC CHEMISTRY II 5.0 Units

Continuation of Chemistry 12A with an introduction to the chemistry of aromatics, amines, enols and enolate ions, carboxylic acids, aldehydes, ketones and biochemical topics focusing on structure, synthesis and mechanisms of reaction. Laboratory work in basic techniques, synthetic methods, qualitative, spectroscopic, and chromatographic analysis techniques designed for students whose interests require a full year in-depth study of organic chemistry.

Prerequisite: Chemistry 12A with a minimum grade of C

CHEM 30A INTRO AND APPLIED CHEMISTRY I 4.0 Units

Chemistry of inorganic compounds, atomic theory, bonding, equations, gas laws, solutions, acid-base theory and oxidation-reduction. Designed to meet the requirements of certain programs in allied health and technological fields and for general education.

Prerequisite: Elementary Algebra or a higher level of mathematics.

CHEM 30B INTRO AND APPLIED CHEMISTRY II 4.0 Units

Continuation of Chemistry 30A with emphasis on organic and biochemical concepts related to human physiological systems.

Prerequisite: Chemistry 30A with a minimum grade of C

CHEM 31 INTRO TO COLLEGE CHEMISTRY 4.0 Units

Elementary concepts of chemistry with emphasis on mathematical calculations; includes nomenclature, stoichiometry, atomic structure, gas laws, and acids and bases. Designed for majors in science and engineering.

Prerequisite: Intermediate Algebra or a higher level of mathematics.

COMMUNICATION STUDIES

CMST 1 FUNDAMENTALS PUBLIC SPEAKING 3.0 Units

Theory and techniques of public speaking. Discovery, development, and criticism of ideas in public discourse through research, reasoning, organization, composition, presentation, and evaluation of various types of speeches including informative and persuasive speeches; includes developing the faculties of critical listening and problem solving.

Recommended Course Preparation: ENG 1A with a minimum grade of C

CMST 2 ORAL INTERPRETATION OF LIT. 3.0 Units

Critical analysis, appreciation, and application of theories and techniques used to perform various forms of literature, including poetry, prose, and drama. Students will learn to evaluate, analyze, edit, and creatively perform selections of literature for an audience.

CMST 3 GROUP COMMUNICATION 3.0 Units

Principles of communication in a variety of group contexts. Theory, application, and evaluation of group communication processes, including norms, roles, problem solving, conflict management, decision making, and leadership. Includes participation in simulation exercises and group activities.

CMST 10 INTERPERSONAL COMMUNICATION 3.0 Units

Exploration, discussion, and evaluation of the principles of the verbal and non-verbal communication process in relationships. Study of theory and research findings and their application to communication in interpersonal relationships in personal and professional contexts.

Recommended Course Preparation: ENG 1A with a minimum grade of C

CMST 46 ARGUMENTATION AND DEBATE 3.0 Units

Methods of critical inquiry and advocacy of contemporary moral, political, economic, and philosophical issues in a diverse multicultural society. Identifying fallacies in reasoning and language, testing evidence and evidence sources, advancing a reasoned position, and defending and refuting arguments. Analysis, presentation, and evaluation of oral and written arguments.

Recommended Course Preparation: ENG 1A with a minimum grade of C

CMST 48 ACTIVITIES IN FORENSICS 1.0 Units

Competition in the areas of public speaking and oral interpretation. Preparation, including research and writing; practice; and participation and performance in intercollegiate speech and debate tournaments.

COMPUTER INFORMATION SYSTEMS

CIS 11 DATA VISUALIZATION TOOLS 3.0 Units

Data visualization is the process of representing information graphically. This course provides a hands-on introduction to various data visualization tools such as Tableau, Excel, Power BI, R Studio. Students use repositories of data for preparation that includes: data formatting, filtering and cleaning. Design principles are applied to create meaningful displays of quantitative and qualitative data to facilitate managerial decision-making.

Strongly Recommended: CIS 54 with a minimum grade of C

CIS 43 PROFESSIONAL COMMUNICATIONS 3.0 Units

This course applies the principles of ethical and effective communication to the creation of letters, memos, emails, and written and oral reports for a variety of business situations. The course emphasizes critical thinking and analysis, planning, organizing, composing, and revising business to create and deliver professional-level oral presentations in-person and virtually. Additional focus will be placed on developing interpersonal skills, team participation skills, and technical report writing skills. Students who have completed or are enrolled in CNT 43 or CS 43 may not receive credit.

Recommended Course Preparation: ENG 1A or ENG 1AEX with a minimum grade of C

CIS 50 INTRO TO COMPUTING INFO TECH 3.0 Units

A comprehensive introduction to the concepts of management and information systems used in business and similar organizations. Covers the role of information systems in business, the need for data and information, how computers are used in business and other organizations to provide information. Focus on information systems, database management system, networking, e-commerce, ethics and security, computer system hardware and software components. Students will interactively solve applied problems

utilizing software productivity tools such as: word processors, spreadsheets, databases, presentation, WWW, and programming languages. Introduce the analytical, written and oral communication skills necessary to communicate effectively in a business computing environment.

CIS 54 EXCEL: INTRO TO SPREADSHEETS 4.0 Units

This is a comprehensive spreadsheet class using Microsoft Excel to create a variety of spreadsheets with emphasis on business applications. Introductory, intermediate, and advanced topics are covered. Introductory topics include entering, editing, and formatting data, creating basic formulas using arithmetic operator and functions, creating charts, saving and printing worksheets. Intermediate topics include using Excel's Table features for sorting filtering and summarizing data, creating PivotTables, working with multiple worksheets and workbooks, naming cells, data validation, recording macros, and protecting worksheets. Advanced topics include using financial functions such as PMT, RATE, FV, creating nested IFs, using VLOOKUP and HLOOKUP functions, using What-If analysis tools such as Goal Seek, one and two variable Data Tables, and Scenario Manager, sharing workbooks, and integrating Excel with other Office applications. Students who have completed or are enrolled in APAT 53 may not receive credit.

Recommended Course Preparation: CIS 50 with a minimum grade of C

CIS 55 INTEGRATING OFFICE APPLICATION 4.0 Units

Develop essential workplace application skills using current Microsoft Office including; Word, Excel, PowerPoint, Access, One Note, Outlook, cloud storage and cloud processing. Emphasis is to design, produce and integrate documents, worksheets, databases and professional presentations. The use of Object Linking and Embedding (OLE) to integrate, share, and collaborate data within and between applications.

Recommended Course Preparation: CIS 50

CIS 59C WEB PROGRAMMING - JAVASCRIPT 3.0 Units

Develop client-side, interactive webpages using JavaScript and/or jQuery scripting languages. Write JavaScript scripts that manipulate with the JavaScript Document Object Model (DOM), control program flow, validate forms, animate images, target frames, and create cookies.

Recommended Course Preparation: CIS 59

CIS 62 PROJECT MANAGEMENT 3.0 Units

Using the Project Management Institute's (PMI) Guide to the Project Management Body of Knowledge (PMBOK), and the Agile SCRUM framework, learn the basic characteristics of projects and project management, with emphasis on the five PMBOK project process groups of initiating, planning, executing, controlling, and closing and the nine knowledge areas of project integration. This introductory course covers the terminology you will need to know, how all the project management processes are linked together, the key areas of expertise you need to know to manage projects successfully. This course focuses on developing project management skills needed in typical technical and business environments. Objectives of project management industry certifications including Project+, CAPM, PMP will be reviewed.

Recommended Course Preparation: CIS 60 with a minimum grade of C

CIS 66 NETWORKING FUNDAMENTALS 3.0 Units

This course provides an introduction to computer networking

Scan here to visit the current Spring 2024 class schedule online



fundamentals skills needed to meet the industry demand for entry-level Network Technicians. Topics include: Ethernet network fundamentals, Local Area Networks (LANs), and Wide Area Networks (WAN) technologies, the Open Systems Interconnection (OSI) model, wiring implementations, network adapters and connectivity devices, IPv4/IPv6 addressing, Voice over IP (VoIP), and wireless standards. Tools to help prevent cyber attacks with IDS (Intrusion Detection Systems), authentication, and encryption are demonstrated. Student labs include: configuration of a SOHO (Small Office/Home Office), a firewall, a virtual private network (VPN), a switch, and a router and documenting a networking using professional drawing software. The responsibilities of an ICT (Information and Communications Technology) professional will be introduced. This course prepares students for the CompTIA Network+ Certification Exam. This professional certification verifies the student has the knowledge equivalent to that of an ICT technician with about 12 months of hands-on experience. Students who have completed or are enrolled in CNT 52 or APIS 52 may not receive credit.

Recommended Course Preparation: CIS 50 with a minimum grade of C

CIS 71A KEYBOARDING (THE ALPHABET) 1.0 Units

Introduction to the alphabet letter keys on the computer keyboard for touch-typing. Learn basic keyboarding techniques for accuracy and speed. This course is the first in a series of sequential courses in keyboarding instruction. Students are advised to take these courses in sequence for best training results.

CIS 71B KEYBOARD (NUMBERS AND SYMBOLS) 1.0 Units

Introduction to the numbers and symbol keys on the computer keyboard for touch typing. Review of alphabetic keys and common punctuation marks. Speed building and accuracy improvement.

Recommended Course Preparation: CIS 71A with a minimum grade of C

CIS 71C SKILLS IMPROVEMENT 1.0 Units

Development of keyboarding skill for those students who have learned the location of the keys on the keyboard by touch and are ready to increase speed and accuracy. Practice keyboarding control of speed and accuracy on straight copy, rough draft copy, and copy with numbers, and symbols. Skill progress is measured by keying text within specified time limits. Students should know the location of the keys on the keyboard before attempting this course. This course is the third module in a sequential series of beginning keyboarding instruction.

Recommended Course Preparation: CIS 71B with a minimum grade of C

CIS 72A DATA MANAGEMENT 1.0 Units

Individualized instruction on the theory and practice of alphabetic, numeric, geographic, and subject filing. Basic principles of filing and effective records management for both paper and electronic filing systems. Introduction to database functions, such as enter, editing, finding, and deleting records, creating queries, and printing report.

CIS 72A is offered on an individualized, hands-on basis. Lab hours are arranged with the instructor. Students need to plan for 4 lab hours per week. This is not an online course. For more information, please contact the instructor.

CIS 72B BASIC OFFICE INTEGRATION 1.0 Units

Using a project-based approach, students will be introduced to features that enable data to be transferred between programs such as Microsoft Office applications or Google applications. Using the techniques introduced in this course, students will be able to incorporate data and charts created in Excel or Google Sheets into Word or Google Docs documents and PowerPoint or Google Presentations, use worksheet data to create tables in an Access database, and use a Word or Google Docs documents to create presentations.

Recommended Course Preparation: CIS 50 or CIS 8 with a minimum grade of C

CIS 73A TEN-KEY SKILL DEVELOPMENT 1.0 Units

Skill development on the computer numeric keypad, electronic calculator including use of memory functions, and data entry using spreadsheets.

CIS 73A is offered on an individualized, hands-on basis. Lab hours are arranged with the instructor. Students need to plan for 4 lab hours per week. This is not an online course. For more information, please contact the instructor.

CIS 74 OFFICE PROCEDURES 3.0 Units

Introduction to office principles, procedures, and technology. Topics include telephone skills, office equipment, working effectively in a team environment, records management, customer service, meeting/event planning, postal/shipping services, utilizing the internet for on-line services and resources, using appropriate software to complete common tasks, written and oral business communications, conflict resolution, and office etiquette. Prepares administrative professionals to work in a diversified workforce with emerging technologies. (Formerly BUSN 74.)

Recommended Course Preparation: CIS 8 and CIS 71C with a minimum grade of C.

CIS 75 OFFICE TECH./COMMUNICATIONS 1.0 Units

Overview of various technologies (such as video- conferencing, cloud services and storage, mobile devices) used for communicating internally and externally in the workplace. Hands-on practice with Outlook (email, contact management, calendaring), cloud-based applications and data storage, and telephone technique.

Recommended Course Preparation: Eligibility for English 1A and CIS 71A with a minimum grade of C

CIS 79 MEDICAL OFFICE PROCEDURES 3.0 Units

Medical office principles and procedures to include telecommunications, scheduling appointments, office equipment, medical documents and word processing, managing medical records, recordkeeping, expense reports, petty cash, billing, postal services, health insurance, coding, and utilizing the Internet for online resources. The importance of medical ethics in application of professional office behavior. Overview of medical law and careers in medical office environment.

Recommended Course Preparation: CIS 8 and CIS 88A with a minimum grade of C

CIS 81A INTRO TO CLOUD COMPUTING 3.0 Units

This course introduces cloud computing which shifts information systems from on premises computing infrastructure to highly scalable internet architectures using current cloud platforms such as AWS, AZURE. The course provides a basic understanding of cloud computing technologies and provides students with the understanding required to effectively evaluate and assess the business and technical benefits of cloud computing and cloud applications. Students analyze a variety of cloud services (storage, servers, software applications), then learn to configure, deploy, and manage cloud facilities. The course also demonstrates/makes available the AWS and/or AZURE platforms for educational, industry career path guidance and career opportunities. This course surveys cloud careers and explores industry demand for cloud skills.

CIS 82B AWS ACADEMY CLOUD SOLUTIONS 2.0 Units

This course focuses on teaching technical expertise in cloud computing and the skills needed to pursue AWS Certified Solutions Architect - Associate certification. This course is delivered through lectures, hands-on labs, and project work. Students have access to course manuals, online knowledge assessments, hands-on labs, practice certification exam, and discount voucher for the

certification exam.

Recommended Course Preparation: CIS 82A with a minimum grade of C

CIS 88A INTRODUCTION TO MICROSOFT WORD 1.5 Units

Develop the skills needed in the workplace to produce common business documents, such as letters, resumes, flyers, and reports. Topics include document creation and editing; use of Microsoft Word features to apply character and paragraph formatting; creating and formatting tables, enhancing visual appeal by incorporating graphics elements, using the mail merge feature, and printing documents.

Recommended Course Preparation: CIS 71A with a minimum grade of C.

CIS 88B ADV MICROSOFT WORD 1.5 Units

Advanced word processing techniques used to produce complex business documents. Includes topics such as format multiple page reports, create tables of contents and indexes, insert footnotes/endnotes, using Word's collaboration features to share documents, create macros to automate tasks, and integrate data from Excel and other programs.

Recommended Course Preparation: CIS 88A with a minimum grade of C.

CIS 89A DESKTOP PRESENTATION 1.0 Units

Desktop presentation design techniques and enhancements. Application using current desktop presentation software. Hands-on experience creating, editing, saving, printing slide shows, incorporating graphics, charts, tables, SmartArt, sounds, and video, enhancing presentations using transitions and animations.

CIS 9002 INTRO TO DATABASE MANAGEMENT 3.0 Units

This course provides the students with an introduction to the core concepts in data and information management. It is centered around the core skills of identifying organizational information requirements, modeling them using conceptual data modeling techniques, converting the conceptual data models into relational data models and verifying its structural characteristics with normalization techniques, and implementing and utilizing a relational database using an industrial-strength database management system. The course will also include coverage of basic database administration tasks and key concepts of data quality and data security. In addition to developing database applications, the course helps the students understand how large-scale packaged systems are highly dependent on the use of Database Management Systems (DBMSs). Building on the transactional database understanding, the course provides an introduction to data and information management technologies that provide decision support capabilities under the broad business intelligence umbrella. In database design, students learn a conceptual representation of an organization's information. In database programming, students implement their database design by creating a physical database using Structured Query Language (SQL) to create, query, manipulate, and control access to the data in a relational database. Students learn to create and maintain database objects such as tables, indexes, views, constraints, and sequences.

Recommended Course Preparation: CIS 50 with a minimum grade of C

COMPUTER NETWORKING TECHNOLOGY

CNT 43 PROFESSIONAL COMMUNICATIONS 3.0 Units

This course applies the principles of ethical and effective communication to the creation of letters, memos, emails, and written and oral reports for a variety of business situations. The course emphasizes critical thinking, and analysis, planning, organizing,

composing, and revising business to create and deliver professional-level oral presentations in-person and virtually. Additional focus will be placed on developing interpersonal skills, team participation skills, and technical report writing skills. Students who have completed or are enrolled in CIS 43 or CS 43 may not receive credit.

Recommended Course Preparation: ENG 1A with a minimum grade of C or ENG 1AEX with a minimum grade of C.

CNT 51 COMPTIAS A+ CERT. COMP. TECH 4.0 Units

This course provides an introduction to the computer hardware and software skills needed to help meet the industry demand for entry-level PC Technicians. This course covers PC hardware, software, security, networking, laptops, printers, operational procedures, operating systems, security, troubleshooting, and mobile devices. The students will study the topics needed to become certified PC technicians. Preparation for the CompTIA A+ certification, which verifies knowledge equivalent to that of an entry-level ICT (Information and Communications Technology) technician with about 12 months of hands-on experience. The responsibilities of an ICT professional will be introduced. Students who have completed or are enrolled in APIS 51 may not receive credit.

Recommended Course Preparation: CIS 50 with a minimum grade of C

CNT 52 NETWORKING FUNDAMENTALS 3.0 Units

This course provides an introduction to computer networking fundamentals skills needed to meet the industry demand for entry-level Network Technicians. Topics include: Ethernet network fundamentals, Local Area Networks (LANs), and Wide Area Networks (WAN) technologies, the Open Systems Interconnection (OSI) model, wiring implementations, network adapters and connectivity devices, IPv4/IPv6 addressing, Voice over IP (VoIP), and wireless standards. Tools to help prevent cyber attacks with IDS (Intrusion Detection Systems), authentication, and encryption are demonstrated. Student labs include: configuration of a SOHO (Small Office/Home Office), a firewall, a virtual private network (VPN), a switch, and a router and documenting a networking using professional drawing software. The responsibilities of an ICT (Information and Communications Technology) professional will CompTIA Network+ Certification Exam. This professional certification verifies the student has the knowledge equivalent to that of an ICT technician with about 12 months of hands-on experience. Students who have completed or are enrolled in CIS 66 may not receive credit.

Recommended Course Preparation: CIS 50 with a minimum grade of C

CNT 55 MCSA-I WINDOWS SERVER 3.0 Units

This course prepares students for the Microsoft's Examination: Installation, Storage and Compute with Windows Server, which is the first of three exams a student must pass to obtain a MCSA (Microsoft Certified Solutions Associate) Certification. By passing this exam, one become a Microsoft Certified Professional (MCP) and gains access to MCP network or computer systems administrator or as a computer network specialist. The topics include installation, storage, and compute features and functionality available in the current Windows Server, Nano Server, images for deployment, storage solutions, data deduplication, high availability, disaster recovery, storage spaces direct, and failover clustering solutions. Also covered: Hyper-V and containers.

Recommended Course Preparation: CNT 52 with a minimum grade of C

CNT 69 NETWORK SECURITY; COMPTIA 3.0 Units

The CompTIA Security+ exam will certify the successful candidate has

Scan here to visit the current Spring 2024 class schedule online



the knowledge and skills required to install and configure systems to secure applications, networks, and devices; perform threat analysis and respond with appropriate mitigation techniques; participate in risk mitigation activities; and operate with an awareness of applicable policies, laws, and regulations. The successful candidate will perform these tasks to support the principles of confidentiality, integrity, and availability. This course provides an introduction to the concepts and practices of secure network design and management using desktop and network operating systems, router and switch operating systems, hardware and software Firewall and VPN technology for wired and wireless systems. The program includes authentication methods and devices, protocol analysis and IP network troubleshooting, strategies for identifying and countering vulnerabilities, network media and topologies in a secure network, intrusion detection and forensic incident response. CompTIA Security+ meets the ISO 17024 standard and is approved by U.S. Department of Defense. Security+ is also compliant with government regulations under the Federal Information Security Management Act (FISMA).

Recommended Course Preparation: CNT 51 and CNT 52 with a minimum grade of C

CNT 7285 CLOUD INFRASTRUCTURE: COMPTIA 3.0 Units

IT professionals need to understand the concepts and principles required to build cloud infrastructure. This course covers the objectives of the CompTIA Cloud+ and Dell/EMC Cloud Infrastructure and Services (CIS) certification exams. Topics include: Cloud Computing Concepts; Models; Disk Storage Systems; Storage Networking; Network Infrastructure; Virtualization Components; Virtualization and the Cloud; Network Management; Performance Tuning; Systems Management; Security in the Cloud and Best Practices; Business Continuity and Disaster Recovery; Testing; Automation; and Changes. The EMC cloud computing reference model includes five fundamental layers (physical, virtual, control, orchestration, and service) and three cross-layer functions (business continuity, security, and service management). Technologies, components, processes, and mechanisms for each layer and cross-layer function will be covered. The course follows the U.S. National Institute of Standards and Technology as a guide for all definitions of cloud computing. Upon completing this course, participants will have the knowledge to make informed decisions on technologies, processes, and mechanisms required to build cloud infrastructure. CompTIA certification is normally valid for three years.

Recommended Course Preparation: CNT 8001 with a minimum grade of C

CNT 7401 RED HAT LINUX ADMINISTRATION I 3.0 Units

This course provides hands-on training covering basic installation, management, configuration, documentation and hardware topics for the Linux/UNIX operating system on workstations in a network environment. The course includes comprehensive coverage of topics related to Linux distributions, installation, administration, X-Windows, and networking. Students who have completed or are enrolled in Computer Science 41 may not receive credit.

Recommended Course Preparation: CIS 50 with a minimum grade of C

CNT 7501 ETHICAL HACKING 3.0 Units

This course introduces the network security specialist to the various methodologies for attacking a network. Students will be introduced to the concepts, principles, and techniques, supplemented by hands-on exercises, for attacking and disabling a network. These methodologies are presented within the context of properly securing the network. The course will emphasize network attack methodologies with the emphasis on student use of network attack techniques and tools and appropriate defenses and countermeasures. Students will receive course content information through a variety of methods: lecture and demonstration of

hacking tools will be used in addition to an virtual environment. Students will receive a hands-on practical hacking.

Strongly Recommended: CNT 52 with a minimum grade of C

CNT 8001 CISCO CCNA1/3 INTRO TO NETWORK 3.0 Units

This is course 1 of 3 of the Cisco CCNA Routing and Switching Certification Objectives. The concepts covered in this course include advances in modern network technologies; Protocols and Models: how network protocols enable devices to access local and remote network resources; Physical Layer: how physical layer protocols, services, and network media support communications across networks; Data Link Layer: how media access control in the data link layer supports communication across networks; Ethernet Switching: how Ethernet operates in a switched network; Network Layer: how routers use network layer protocols and services to enable end-to-end connectivity; Address Resolution: Protocol (ARP) and Neighbor Discovery (ND) enable communication on a local area network; Transport Layer & Application Layer: Explain the operation of layers protocols in providing support to end-user applications. The hands-on labs include implementation of initial settings including passwords, IP addressing, and default gateway parameters on a network switch and end devices; Basic Switch and Device Configuration; Calculation of numbers between decimal and binary systems; IPv4 Addressing: IPv4 subnetting scheme to segment a network; Implementing an IPv6 addressing scheme; ICMP and various tools to test network connectivity; Network Security Fundamentals: Configure switches and routers with device hardening features to enhance security; Build a Small Network: Implement a network design for a small network to include a router, a switch, and end devices.

Recommended Course Preparation: CIS 50 with a minimum grade of C

CNT 8003 CISCO CCNA3/3 ENTERPRISE NET 3.0 Units

This is course 3 of 3 of the Cisco CCNA Routing and Switching Certification Objectives. The concepts covered in this course include the operation of single-area OSPFv2 in both point-to-point and broadcast multi-access networks; vulnerabilities, threats, and exploits and how they can be mitigated to enhance network security; ACLs operation as part of a network security policy; WAN access technologies used to satisfy business requirements; VPNs and IPsec and their use to secure site-to-site and remote access connectivity; networking devices implementing QoS; Network Design and characteristics of scalable network architectures; network automation enabled through RESTful APIs and configuration management tools; purpose and characteristics of network virtualization. The hands-on labs include the implementation of single-area OSPFv2 in both point-to-point and broadcast multi-access networks; IPv4 ACLs to filter traffic and secure administrative access; NAT services on the edge router to provide IPv4 address scalability; network management protocols to monitor the network; and Troubleshooting LANs and enterprise networks.

Strongly Recommended: CNT 8002 with a minimum grade of C

COMPUTER SCIENCE

CS 1 COMPUTING FUNDAMENTALS I 4.0 Units

Introduction to programming and problem-solving using C++. Problem solving techniques and algorithms; program design, development, style, testing and debugging. C++ syntax covered includes: variables; data types; operators and expressions; control structures; library and user-defined functions; basic file input/output; binary file input/output; arrays; vectors; abstract data types including user-defined data structures and enumerated data types.

Recommended Course Preparation: MATH 107 and CS 7 with a minimum grade of C

CS 2 COMPUTING FUNDAMENTALS II 4.0 Units
 Application of software engineering techniques to the design and development of large programs. Object-oriented programming methods and problem-solving strategies applied to intermediate-level problems using C++. Includes pointers and dynamic allocation; classes; encapsulation; inheritance and polymorphism; object and function overloading; recursive algorithms; data abstraction and structures.
Prerequisite: CS 1 with a minimum grade of C

CS 5 INTRO TO MACHINE LEARNING 3.0 Units
 An introduction to machine learning (ML), with an emphasis on programming ML applications and using modern ML libraries. Basic discrete mathematics and linear algebra. An overview of various supervised learning classifiers. Unsupervised learning via clustering. Reinforcement learning with model-based and model-free approaches. Safety and ethical concerns of ML.
Prerequisite: CS 1
Recommended Course Preparation: CS 7 and MATH 40

CS 7 INTRO TO COMPUTER PROGRAMMING 3.0 Units
 An introductory course in computer programming concepts and fundamental coding skills using object-oriented languages like Python. Material includes problem-solving techniques, design of algorithms, and common programming constructs such as variables, expressions, input/output, decision-making, loops and arrays.

CS 17 DISCRETE MATH STRUCTURES 4.0 Units
 Designed for majors in mathematics and computer science, this course provides an introduction to discrete Science and their applications. Course content includes: Propositional and predicate logic; rules of inference; quantifiers; elements of integer number theory; set theory; methods of proof; induction; combinatorics and discrete probability; functions and relations; recursive definitions and recurrence relations; elements of graph theory and trees. Applications include: analysis of algorithms, Boolean algebras and digital logic circuits. Students who have completed, or are enrolled in, MATH 10 may not receive credit.
Prerequisite: MATH 1 and CS 1 with a minimum grade of C (May be taken concurrently)

A TI-84 or TI-83 calculator or internet-based software may be required for some sections of this course. There may be a fee associated with these materials. Consult with the instructor or bookstore before registering for this course.

CS 20 ADV PROG W/DATA STRUCTURES/C++ 4.0 Units
 Design and implementation of complex programs in C++ using a variety of fundamental data structures and algorithms. Includes the design and implementation recursive functions, of abstract data types, linked lists, stacks, queues, binary trees, hash tables, search and sorting algorithms, graphs, heaps, and algorithm analysis.
Recommended Course Preparation: CS 2 with a minimum grade of C

CS 21 ASSEMBLY LANGUAGE PROGRAMMING 4.0 Units
 Basics of machine architecture, cpu architecture and design, machine language, assembly language, operating system and higher level language interface. Data representation, instruction representation and execution, addressing techniques and use of macros. Space and time efficiency issues. Input/output including video modes. Procedures including parameter passing and linkage to higher level languages.
Prerequisite: CS 1 with a minimum grade of C

CS 41 RED HAT LINUX ADMIN. I 3.0 Units
 This course provides hands-on training covering basic installation, management, configuration, documentation and hardware topics

for the Linux/UNIX operating system on workstations in a network environment. The course includes comprehensive coverage of topics related to Linux distributions, installation, administration, X-Windows, and networking. Students who have completed or are enrolled in CNT 7401 may not receive credit.
Recommended Course Preparation: CIS 50 with a minimum grade of C

CS 43 PROFESSIONAL COMMUNICATIONS 3.0 Units
 This course applies the principles of ethical and effective communication to the creation of letters, memos, emails, and written and oral reports for a variety of business situations. The course emphasizes critical thinking, and analysis, planning, organizing, composing, and revising business documents using word processing software for written documents and presentation-graphics software to create and deliver professional-level oral presentations in-person and virtually. Additional focus will be placed on developing interpersonal skills, team participation skills, and technical report writing skills. Students who have completed or are enrolled in Business 43, Computer Networking Technology 43, or Computer Information Systems 43 may not receive credit.
Recommended Course Preparation: ENG 1A or ENG 1AEX with a minimum grade of C

CS 47 CAPSTONE PROJECT 3.0 Units
 This is intended as a culminating experience within a degree or certificate sequence. Working individually or in a small team, you will develop a large-scale work-like project, driven by client needs, and requiring planning, implementation, documentation and presentation of the solution. Based on client requirements, each student or student team will design and implement a solution in a systematic and organized manner, breaking the project into logical sub-components and/or steps. Each student or student team will also prepare relevant written materials and give an oral presentation of the final product.
Recommended Course Preparation: CS 1 or CS 31, CNT 52, CIS 43, CNT 43, CS 43, CIS 60, CIS 62, CS 45

DANCE

DANC 2A JAZZ DANCE BEGINNING 1.0 Units
 This course covers various movement forms with an emphasis on rhythm, style and proper techniques. Students will learn a variety of jazz phrases and will be expected to perform a jazz dance at the introductory level by the end of the semester.

DANC 2B JAZZ DANCE INTERMEDIATE 1.0 Units
 This course covers various movement forms with an emphasis on rhythm, style and proper techniques. Students will learn a variety of jazz phrases and will be expected to choreograph and perform a jazz dance at the advanced beginning/intermediate level by the end of the semester.
Recommended Course Preparation: DANC 2A with a minimum grade of C

EARLY CARE AND EDUCATION

ECE 10 INTRODUCTION TO EDUCATION 3.0 Units
 This course introduces students to the concepts and issues related

Scan here to visit the current Spring 2024 class schedule online



to teaching diverse learners in today's contemporary schools, TK through the 12th grade. Topics include teaching as a profession and career, historical and philosophical foundations of the American education system, inequities in the field, actions to address inequities, contemporary education issues, California's content standards and frameworks, and teacher performance standards. In addition to class time, the course requires a minimum of 54 hours of structured fieldwork in public school elementary classrooms that represent California's diverse student population, and includes cooperation with at least one carefully selected and campus-approved certificated classroom teacher.

ECE 40 SOCIAL & EMOTIONAL FOUNDATIONS 3.0 Units

This course will focus on the healthy social and emotional development of young children ages 0-8, as the foundation for early learning. Students will identify the role of the teacher in establishing learning environments that promote the healthy social and emotional development of young children, the underlying basis for quality teacher-child interactions.

Recommended Course Preparation: ECE 56 and ECE 62 with a minimum grade of C

ECE 50 EARLY CHILDHOOD PRINCIPLES 3.0 Units

Historical contexts and theoretical perspectives of developmentally appropriate practice in early care and education for children birth through age eight. Explores the typical roles and expectations of early childhood educators. Identifies professional ethics, career pathways, and professional standards. Introduces best practices for developmentally appropriate learning environments, curriculum, and effective pedagogy for young children, including how play contributes to children's learning, growth, and development.

ECE 54 CHILD HEALTH, SAFETY & NUTR. 3.0 Units

This course covers aspects of nutrition, health, and safety that promote and maintain the health and well-being of all children and adults who work with young children. Topics include health and nutritional guidelines; maintaining safe and healthy learning environments; state regulations, policies, and procedures; common childhood illnesses and infectious diseases; school-family collaboration; and emergency preparedness, first aid, and injury prevention.

ECE 56 CHILD GROWTH AND DEVELOPMENT 3.0 Units

A study of the major physical, psychosocial, and cognitive/ language developmental milestones for children, both typical and atypical, from conception through adolescence. There will be an emphasis on interactions between maturational processes and environmental factors. While studying developmental theory and investigative research methodologies, students will observe children, evaluate individual differences and analyze characteristics of development at various stages.

ECE 62 CHILD, FAMILY AND COMMUNITY 3.0 Units

The processes of socialization and identity development, focusing on the interrelationship of family, school, and community. Examines the influence of multiple societal contexts. Explores the role of collaboration between family, community, and schools in supporting children's development.

ECE 63 EARLY CHILDHOOD CURRICULUM 4.0 Units

This course offers students the opportunity for professional application of the principles of child growth and development in the study of play based, inclusive, emergent curriculum within the physical environment of the infant, toddler and preschool classrooms. Students will learn of a variety of program models used and explore how program models inform curriculum planning. The learning experiences will include program content pertaining to

the use of materials, the facilitation and guidance of all children's experiences based on what is culturally and developmentally appropriate for children; utilizing best practices in meeting the children's physical, social, emotional, cognitive and creative needs.

Prerequisite: ECE 50 and ECE 56 with a minimum grade of C

ECE 69 CHILD STUDY: OBSERVATION 3.0 Units

Introduces the appropriate use of assessment and observation tools and strategies to document young children's development and learning. The use of findings to inform and plan learning environments and experiences are emphasized. Recording strategies, rating systems, portfolios, and multiple assessment tools will be discussed, along with strategies for collaboration with families and professionals.

Prerequisite: ECE 56 with a minimum grade of C

ECE 79 TEACHING IN A DIVERSE SOCIETY 3.0 Units

Examines the historical and current perspectives on diversity, equity, inclusion, and the impact of systemic societal influences on children's development, their learning, and school experiences. Strategies for developmentally, culturally, and linguistically appropriate anti-bias curriculum will be explored as well as approaches to promote inclusive and anti-racist classroom communities. Self-examination and reflection on one's values, beliefs, and attitudes about social identities, stereotypes, conscious and unconscious bias will be emphasized. The class will focus heavily on anti-bias approaches to teaching, curriculum and family partnerships.

Recommended Course Preparation: ECE 62 with a minimum grade of C

ECE 87 QUALITY ENVIRONMENTS INFANTS 3.0 Units

Applies current theory and research to the care and education of infants and toddlers in group care. Examines essential policies, classroom environments, caregiving principles and practices that lead to quality care and developmentally appropriate curriculum for infants and toddlers which is culturally sensitive and supports families.

Strongly Recommended: ECE 67 with a minimum grade of C

ECE 90 PRACTICUM-SUPERVISED EXP. 4.0 Units

Practicum experience working with young children under the supervision of an ECE/CD faculty; Students will utilize practical classroom experiences to make connections between theory and practice, develop professional behaviors, and build comprehensive understanding of children and families. Child centered, play oriented approaches to teaching, learning and assessment and knowledge of curriculum content areas will be emphasized as student teachers design, implement and evaluate experiences that promote positive development and learning for all young children.

Prerequisite: ECE 50 and ECE 56 and ECE 62 and ECE 63 with a minimum grade of C

ECE 91 ADAPTIVE CURRICULUM EX. NEEDS 3.0 Units

Provides direct experience working with young children in special day classes or inclusive settings. Application of intervention strategies using best practices of early childhood development and special education in adapting curriculum to meet the individual needs of children. Observation of the assessment process by the special education team and assisting in the implementation of the educational plan. Includes the role of the teacher as a professional working in partnership with families, collaboration with interdisciplinary teams and cultural competence.

Prerequisite: ECE 60 and ECE 90 with a minimum grade of C

ECONOMICS

ECON 1 PRINCIPLES OF MICROECONOMICS 3.0 Units

Economic analysis of market systems, price theory, including supply and demand analysis, marginal utility, elasticity, cost and revenue concepts, perfect and imperfect competition, international trade theory, pricing of the factors of production, poverty and income inequalities.

Prerequisite: Elementary Algebra or a higher level of mathematics.

Recommended Course Preparation: Intermediate Algebra or a higher level of mathematics.

ECON 2 PRINCIPLES OF MACROECONOMICS 3.0 Units

Economic analysis of the theory of income determination, including national income analysis, business cycles, the consumption function, the multiplier, fiscal policy, monetary policy, money and banking, the public debt, economic growth and development, comparative economic systems and international trade. Prerequisite: Elementary Algebra or a higher level of mathematics.

Recommended Course Preparation: Intermediate Algebra or a higher level of mathematics.

ECON 10 GENERAL ECONOMICS 3.0 Units

Survey of the economic system of the United States, covering such macroeconomic and microeconomic topics as supply and demand, firms' output and pricing decisions, international trade, comparative economic systems, economic growth, business cycles, fiscal and monetary policy, labor, and money banking.

EMERGENCY MEDICAL SERVICES

EMS 16 PARAMEDIC CLINICAL OCCUPATION 3.0 Units

Occupational work experience course that provides instruction to enhance student's knowledge of emergency care in a clinical setting. Students are provided access to adequate numbers of patients, proportionally distributed by illness, injury, gender, age, and common problems encountered in the delivery of emergency care appropriate to the level of the Emergency Medical Services Profession(s). Hospital/clinical experiences include the operating room, recovery room, intensive care unit, coronary care unit, labor and delivery room, pediatrics, and emergency department, and include exposure to an adequate number of pediatric, obstetric, psychiatric, and geriatric patients.

Prerequisite: EMS 11, EMS 13, EMS 10 and EMS 12 with a minimum grade of C

EMS 17 PARAMEDIC CAPSTONE OCCUPATION 1.0 Units

An occupational work experience course that provides practicum experience for paramedic students to observe and participate in emergency medical care supervised by a preceptor in an emergency response vehicle. Requires a minimum of 480 hours, and students must document at least 40 advanced life support (ALS) patient contacts. Student will provide the full continuum of care from initial contact to transfer of care at the receiving facility for half of all ALS contacts. Students must obtain minimum competency as a Team Leader. The field internship provides the student with an opportunity to serve as team leader in a variety of pre-hospital advanced life support emergency medical situations.

Prerequisite: EMS 16 with a minimum grade of C

EMS 20 EMERGENCY MEDICAL TECHNICIAN 7.0 Units

Provides training in the foundation skills and knowledge required

of the EMT scope of practice. The EMT certification is the minimum requirement for ambulance attendants and most entry-level firefighter positions. EMT certification is also required for entry into paramedic training. This training program is accredited by the Alameda County Emergency Medical Services District.

Prerequisite: EMS 30 with a minimum grade of B

EMS 30 EMERGENCY MEDICAL RESPONDER 3.0 Units

Development of knowledge and skills necessary for recognizing and caring for victims in emergency situations, including cardiopulmonary resuscitation, patient assessment, cardiopulmonary resuscitation with the use of an automated external defibrillator, and prevention of disease transmission. Designed for emergency medical responders in the public safety field. Successful completion of the psychomotor skills tests and successful completion of the course with a score of 80%, and achieving a score on the course summative final at (80%) qualifies the student for an Emergency Medical Responder (EMR) Certificate issued by the Emergency Care and Safety Institute (ECSI).

Recommended Course Preparation: EMS 70B with a minimum grade of C

EMS 62 BASIC MEDICAL TERMINOLOGY 3.0 Units

A basic course in medical terminology designed for students in studying for Allied Health careers such as Surgical Technologist, Paramedic, Pre-nursing, and Radiology Technician. Medical vocabulary with concentration on prefixes, suffixes, and root words. Emphasis on word dissection, definitions as applied to the body systems including the terminology used in surgical procedures. Concepts focus on comprehensive terminology, pronunciation and spelling core.

EMS 70 CPR FOR HEALTH CARE PROVIDERS 0.5 Units

Development of knowledge, skills and personal judgment necessary to initiate and perform basic life support techniques as a health care professional. Successful completion of the knowledge and skills tests qualifies for an American Heart Association Basic Life Support Certificate.

EMS 91 EMERGENCY MED. TECH- REFRESHER 1.0 Units

Provides a refresher in the foundation and knowledge required of the EMT-1 scope of practice. The EMT-1 certification is the minimum requirement for ambulance attendants and most entry-level firefighter positions. EMT-1 certification is also required for entry into paramedic training. This refresher program is accredited by the Alameda County Emergency Medical Services Agency. The course provides 24 hours of continuing education units or a course completion certificate. Additionally, the course provides skills verification testing that EMTs must complete every two years.

Prerequisite: Proof of California State EMSA or National Registration Certification as an "Emergency Medical Technician." Certification must be current, or expired less than 6 months. Student may also present documentation from the National Registry of Emergency Medical Technicians showing failure of initial three attempts at NREMT Certification Examination which now requires completion of EMS 91 for additional attempts to register for certification examination.

ENGINEERING

ENGR 1 INTRODUCTION TO ENGINEERING 2.0 Units

Introduction to careers, activities, and topics related to the field

Scan here to visit the current Spring 2024 class schedule online



of engineering, including computer applications to design and problem solving.

Recommended Course Preparation: Eligibility for ENG 1A/1AEX with a minimum grade of C

ENGR 23 ENGINEERING GRAPHICS 3.0 Units

Introduction to the engineering-design process, and to technical graphic communications tools used by engineers. Conceptual design of products. Development of spatial reasoning skills. Orthographic and axonometric projection-drawing techniques. Tolerance analysis for fabrication. Documentation of designs through engineering working drawings. Use SolidWorks Computer-Assisted Drawing software as a design tool. Basic CAD 3-Dimensional solid-modeling. *Recommended Course Preparation: MATH 39, ENG 1A or ENG 1AEX with a minimum grade of C*

ENGR 37 APPLIED STATICS AND MATERIALS 3.0 Units

Applied statics, mechanics of materials, and materials science. Topics include stress, strain, types of forces, moments, moment of inertia, friction, truss structures, centers of gravity, modulus of elasticity, fasteners, chemistry and atomic structure, crystalline structures, phase diagrams. This course is designed for Engineering Technology majors; it is not intended for students pursuing the Engineering Requirements (Transfer Preparation) path.

Prerequisite: MATH 39 with a minimum grade of C

ENGR 44 INTRO TO CIRCUIT ANALYSIS 4.0 Units

Introduction to analysis methods for electrical circuits. Topics include general techniques for circuit analysis, simple resistive circuits, inductors, capacitors, mutual coupling, operational amplifier circuits, transient and steady-state analysis of first- order and second-order circuits. Lab topics include introduction to the use of electronic test equipment, designing, assembling, testing and simulating various resistive, LC, RC and operational amplifier circuits. Simulations are done with available circuit simulations codes such as PSpice.

Prerequisite: PHYS 1A with a minimum grade of C

ENGR 46 MATERIALS OF ENGINEERING 4.0 Units

Application of principles of chemistry and physics to the properties of engineering materials; the relation of microstructure to mechanical, electrical, thermal and corrosion properties of metals; ceramics and polymers.

Prerequisite: PHYS 1A and CHEM 1A with a minimum grade of C

Las Positas College

English Flow Chart & Guided Self-Placement

All students are required to take the English Guided Self-Placement in CLASS-Web in order to register for an English course. Students can choose either 1A or 1AEX, which both meet GE and transfer requirements. English 1AEX is recommended for those in need of additional class time for reading and writing support and time to complete assignments.

Visit the LPC Assessment Center website for more information on English placement or ESL assessment: <http://laspositascollege.edu/assessment/>

TRANSFER-LEVEL ENGLISH

English 4 -or- English 7
3 hours lecture
Per Week

English 1A
3 hours lecture + 1 hour lab
per week

Fewer Hours

English 1AEX
3 hour lecture + 3 hour lab
Per week

More Support

START HERE

LANGUAGE AND RATIONALITY

A.A. REQUIREMENTS	6 SEMESTER UNITS
ENGLISH COMPOSITION	
English 1A -or- English 1AEX.....	3 units
AND	
WRITING AND CRITICAL THINKING	
English 4 (Fiction) -or- English 7 (Non-Fiction).....	3 Units
A.S. REQUIREMENTS	3 Semester Units
ENGLISH COMPOSITION	
English 1A -or- English 1AEX.....	3 Units
<u>TRANSFER REQUIREMENTS</u>	

Students should consult CSU GE and IGETC requirements or see a counselor

ENGLISH

ENG 1A CRITICAL READING AND COMP 3.0 Units

Integrated approach to reading, writing, and critical thinking intended to develop ability to read and write complex, college-level prose. Examination of ideas in relation to individual's worldview and contexts from which these ideas arise. Some research required.

Prerequisite: Eligibility for college-level composition as as determined by college assessment or other appropriate method.

ENG 1AEX CRITICAL READING COMP EXPANDED 4.0 Units

Integrated approach to reading, writing, and critical thinking intended to develop ability to read and write complex, college-level prose. Examination of ideas in relation to individual's worldview and contexts from which these ideas arise. Some research required. English 1AEX provides students with an extra unit of lab to support students in reading and writing complex, college-level prose. Students who have completed, or are enrolled in, ENG 1A may not receive credit.

Prerequisite: Eligibility for college-level composition as as determined by college assessment or other appropriate method.

ENG 4 CRITICAL THINKING/WRITING LIT 3.0 Units

Develops critical thinking, reading, and writing skills as they apply to the analysis of fiction, poetry and drama; literary criticism; and related non-fiction from diverse cultural sources and perspectives. Emphasis on the techniques and principles of effective written argument as they apply to literature. Some research required.

Prerequisite: ENG 1A or ENG 1AEX with a minimum grade of C

ENG 7 CRITICAL THINKING/WRITING 3.0 Units

Develops critical thinking, reading, and writing skills as they apply to the textual analysis of primary and secondary book-length works from a range of academic and cultural contexts. Emphasis on the techniques and principles of effective written argument in research-

based writing across disciplines.

Prerequisite: ENG 1A or ENG 1AEX with a minimum grade of C

ENG 12A CRAFT OF WRITING FICTION 3.0 Units

Practice in writing fiction. Developing internal and external sources for stories and novels; biographical sources, characterization, plot, points-of-view, narrative techniques; analysis and criticism of published writing and individual's own work.

Recommended Course Preparation: ENG 11 with a minimum grade of C and eligibility for ENG 1A.

ENG 12B CRAFT OF WRITING FICT: INTERMED 3.0 Units

Practice in writing fiction at an intermediate level. Builds on the skills developed in English 12A by requiring the use of vivid description, specific detail, dynamic and rounded character development, consistent point of view, and logical plotting that avoids cliché. Focus on developing themes that create intellectual or emotional resonance. Expectation of sentence structure, grammar, and format accuracy. Develop internal and external sources for stories and novels; analysis and criticism of published short fiction and a book-length work; analysis and criticism of peer work and individual's own work. Requires submission for publication at the end of the semester.

Recommended Course Preparation: ENG 12A with a minimum grade of C and ENG 1A with a minimum grade of C

ENG 12C CRAFT OF WRITING FICTION: ADV. 3.0 Units

Practice in writing fiction at an advanced level. Builds on the intermediate skills developed in English 12B by requiring a mastery of description, detail, character development, consistent point of view, and logical plotting that avoids cliché. Focus on achieving themes that create intellectual or emotional resonance. Expectation of sentence structure, grammar, and format accuracy. Develop internal and external sources for stories and novels; analysis and criticism of published short fiction and a presentation about the craft in a book-length work; analysis and criticism of peer work and individual's own work. Requires submission for publication at the end of the semester; analysis and criticism of peer work and individual's own work.

Prerequisite: ENG 12B with a minimum grade of C Recommended Course Preparation: ENG 1A or ENG 1AEX with a minimum grade of C

ENG 13A THE CRAFT OF WRITING POETRY 3.0 Units

Practice in writing poetry, using materials drawn from published poetry and individual's own work for analysis and criticism, with a focus on techniques of revision.

Recommended Course Preparation: ENG 11 or ENG 1A or ENG 1AEX with a minimum grade of C

ENG 13B WRITING POETRY: INTERMEDIATE 3.0 Units

Continued practice in writing poetry, using materials drawn from published poetry and individual's own work for analysis and criticism, with a focus on techniques of revision and submission for publication.

Prerequisite: ENG 13A with a minimum grade of C

ENG 19A JOURNAL OF ARTS AND WRITING A 3.0 Units

Creation of a literary-style student magazine. Practical training in the managing, editing, formatting, and printing of a literary magazine. Enrollment constitutes the staff of the magazine. Students who have completed, or are enrolled in, JAMS 19A may not receive credit.

ENG 19B JOURNAL OF ARTS AND WRITING B 3.0 Units

Creation of a literary-style student magazine. Practical intermediate-level training in the managing, editing, formatting, and printing of a literary supplement and/or magazine with a focus on the production

process, including copy editing, design, layout, proofreading, working with the printer, and digital and print distribution. Enrollment constitutes the staff of the magazine. Students who have completed, or are enrolled in, JAMS 19B may not receive credit.

Prerequisite: ENG 19A or JAMS 19A with a minimum grade of C

ENG 35 MODERN AMERICAN LITERATURE 3.0 Units

U.S. literature from the second half of the 19th century to the present, including poetry, drama, prose fiction, and essays. Emphasizes literary analysis and the exploration each work in relation to its social, cultural and historical contexts.

Prerequisite: ENG 1A with a minimum grade of C

ENG 45 STUDIES IN FICTION 3.0 Units

Form, development, and cultural insights of the novel and short story; exploration of particular themes or periods as reflected in works of fiction.

Prerequisite: ENG 1A with a minimum grade of C

ENGLISH AS A SECOND LANGUAGE

ESL 24 ADV. READING AND COMPOSITION I 6.0 Units

This is the first semester of a one-year advanced reading and writing course for academic purposes. Emphasis is on critical reading techniques and writing expository essays as well as on grammar and vocabulary development.

Prerequisite: ESL 121B or NESL 221B with a minimum grade of Pass or Placement through the ESL assessment process

ESL 26 ADVANCED EDITING 3.0 Units

This course is designed to increase students' awareness of their own use of written language, and give them practice in editing strategies which will enable them to use linguistic forms accurately, meaningfully and appropriately in written expression.

Prerequisite: ESL 120B or NESL 220B and ESL 121B or NESL 221B with a minimum grade of P or placement through the ESL assessment process.

Students are advised to enroll concurrently in ESL 26 and ESL 24 or 25.

ESL 100 BEGINNING SPELLING FOR ENGLISH 1.0 Units

This is a one semester beginning spelling class, designed to enable English language learners to recognize and use beginning sound/spelling patterns in English, develop an understanding of the sounds and symbols of English, including open/closed syllables, short and long vowel sounds, consonant and consonant cluster sounds, as well as the spelling of homophones and other problem words in everyday English. The course will also focus on basic dictionary skills to improve student autonomy.

ESL 113 SPEAKING AND LISTENING FLUENCY 2.0 Units

This is an oral communication course that will enable students to develop advanced speaking and listening fluency enable students to fluently use linguistic forms accurately, meaningfully and appropriately, emphasizing academic and professional discourse. Students will practice listening and responding to academic lectures and presentations like TED Talks, including note-taking, summarizing, and other forms of critical analysis. Speaking practice will emphasize advanced rhetorical strategies through group discussions, debates, impromptu speeches and oral presentations and cultural norms in academic and professional contexts. It is the

Scan here to visit the current Spring 2024 class schedule online



fifth and highest level of the ESL Speaking and Listening Fluency Pathway.

Prerequisite: ESL 123 or NESL 223 or ESL 126 or NESL 226 with a minimum grade of Pass, or Placement into Advanced ESL courses through the ESL Assessment Process.

ESL 120A INTERM. GRAMMAR/READ, WRITE I 3.0 Units

This is the first semester of a one-year course in intermediate grammar for academic writing and reading designed to enable students to use linguistic forms accurately, meaningfully and appropriately in written expression. This course focuses on compound and complex sentences, verb tense and form, and modals. This course also emphasizes grammar analysis, detecting and correcting grammatical errors, and self-editing skills.

Prerequisite: ESL 130B or appropriate skill level demonstrated through

the ESL assessment process.

Students are advised to enroll concurrently in ESL 120A and 121A and 123 or 126.

ESL 120B INTERM. GRAMMAR/READ, WRITE II 3.0 Units

This is the second semester of a one-year course in intermediate grammar for academic writing and reading designed to enable students to use linguistic forms accurately, meaningfully and appropriately in written expression. The course focuses on compound and complex sentences and short paragraphs, overview of the verb tense system in English, verb forms with gerunds and infinitives, verb forms in modifying phrases, and modals. This course also emphasizes analyzing grammar and meaning, detecting and correcting grammatical errors, and self-editing skills.

Prerequisite: ESL 120A or appropriate skill level demonstrated through the ESL assessment process. Students are advised to enroll concurrently in ESL 120B, 121B, and 123 or 126.

ESL 121A INTERM. READING AND WRITING 6.0 Units

This is the first semester of a one-year course in intermediate academic writing and reading. Classes will focus on writing sentences, paragraphs and compositions, developing strategies for reading comprehension and flexibility, on interactive reading, and on academic vocabulary development. Students will develop cultural understanding, vocabulary, and fluency through a variety of academic writing and reading tasks.

Prerequisite: ESL 131B with a minimum grade of Pass or placement through the ESL assessment process.

Students are advised to enroll concurrently in ESL 120A, 121A and 123 or 126.

ESL 121B HIGH-INTERMEDIATE READING 6.0 Units

This is the second semester of a one-year course in intermediate academic writing and reading. Classes will focus on writing sentences, paragraphs and compositions, developing strategies for reading comprehension and flexibility, on interactive reading, and academic vocabulary development. Students will develop cultural understanding and fluency through a variety of academic writing and reading tasks.

Prerequisite: ESL 121A with a minimum grade of C or placement through the ESL assessment process.

Students are advised to enroll concurrently in ESL 120B, 121B and 123 or 126.

ESL 126 INTER. PRONUNCIATION AND FLUENCY 2.0 Units

Focused practice on recognizing and producing individual speech sounds, stress patterns, rhythm and intonation patterns, and grammatical signals through activities such as oral presentations, role play, authentic dialogue, and reading presentations

Prerequisite: ESL 130B or ESL 131B or ESL 136 with a minimum grade of P or placement through ESL assessment process

ESL 130A BEGINNING GRAMMAR FOR READING 3.0 Units

This is the first semester of a one-year course in beginning grammar for academic purposes designed to enable students to understand and use English accurately, meaningfully and appropriately. The course focuses on the connection between vocabulary and grammar, simple and compound sentences, phrases, verb forms, and verb tenses, especially simple present, simple past, and present progressive.

Recommended Course Preparation: Placement through the ESL assessment process

Students are advised to enroll concurrently in ESL 130A, 131A, and 133 or 136.

ESL 130B HIGH-BEGINNING GRAMMAR 3.0 Units

This is the second semester of a one-year course in beginning grammar for academic purposes designed to enable students

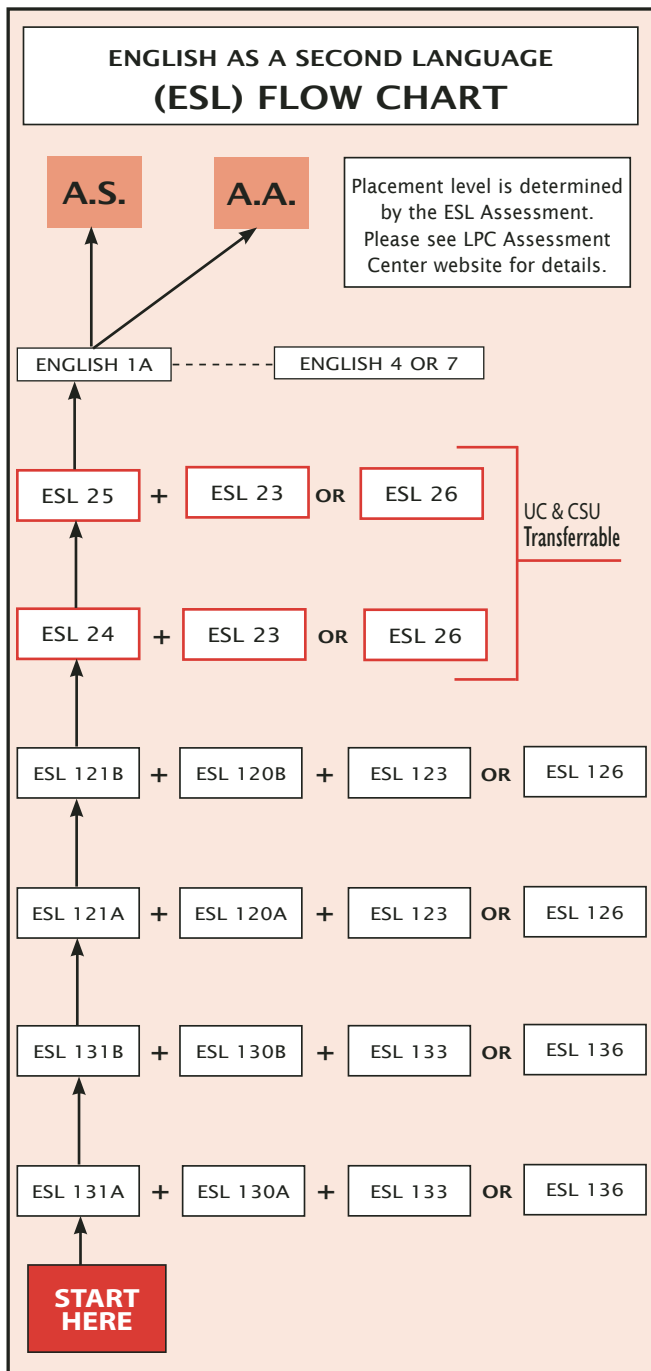

to identify and use linguistic forms accurately, meaningfully and appropriately in written expression. The course focuses on simple and compound sentences, word order, verb tenses: simple present, past, and future as well as present and past progressive, verb forms, modals, phrases, and vocabulary development.

Prerequisite: ESL 130A or NESL 230A with a minimum grade of P or placement through the ESL assessment process.

Students are advised to enroll concurrently in ESL 130B, 131B, and 133 or 136.

ESL 131A BEGINNING READING AND WRITING 6.0 Units

This is the first semester of a one-year course in beginning academic writing and reading. Classes will focus on writing simple and compound sentences in short paragraphs, on developing strategies for increasing reading comprehension and flexibility, on interactive reading, and on developing academic vocabulary. Students will develop cultural understanding and fluency through a variety of writing and reading tasks.

Recommended Course Preparation: Appropriate skill level demonstrated through the ESL assessment process.

Students are advised to enroll concurrently in ESL 131A, 130A, and 133 or 136.

ESL 131B HIGH-BEG. READING AND WRITING 6.0 Units

This is the second semester of a one-year course in beginning academic writing and reading. Classes will focus on writing simple, compound, and complex sentences in structured paragraphs, on developing strategies for increasing reading comprehension and flexibility, on interactive reading, and on developing academic vocabulary. Students will develop cultural understanding and fluency through a variety of writing and reading tasks.

Prerequisite: ESL 131A or NESL 231A completed with a minimum grade of Pass or placement through the ESL assessment process.

Students are advised to enroll concurrently in ESL 131B and 130B, and 133 or 136.

ESL 136 PRONUNCIATION AND FLUENCY 2.0 Units

Focused practice on recognizing and producing individual speech sounds, stress patterns, rhythm and intonation patterns, and grammatical signals through activities such as oral presentations, role play, authentic dialogue, and presentations. Students will focus on developing listener friendly pronunciation. Course content includes individual as well as group work.

Recommended Course Preparation: Placement through the ESL assessment process.

ENVIRONMENTAL STUDIES

EVST 5 ENERGY AND SUSTAINABILITY 3.0 Units

Introduction and exploration of Energy production, utilization, management, and the effects on society, and the environment. This course will also compare and contrast current and future renewable and non renewable methods of energy generation, auditing, and conservation.

Recommended Course Preparation: Eligibility for ENG 1A

ETHNIC STUDIES

ETHS 5 PSYCH. OF RACE AND IDENTITY 3.0 Units

This course is an introduction to the impact of race and ethnicity on identity in the United States, which focuses on how these influence human behavior and shape one's understanding of the world around them. We will study a variety of topics related to race, ethnicity, social and cultural group developmental norms

and the extent of influence these norms may have on individual's worldview. This course seeks to strengthen diversity awareness and knowledge by engaging in difficult discussions surrounding race and identity. This course will review a broad range of theories and research findings regarding race and ethnicity's influence on human behavior and cognitive process. Topics covered include stereotypes, prejudice, discrimination, racism, the intersection between race, ethnicity and other forms of oppression, privilege, and identity development. Students who have completed, or are enrolled in, PSYC 21 may not receive credit.

Recommended Course Preparation: PSYC 1 with a minimum grade of C

ETHS 6 INTRO TO RACE AND ETHNICITY 3.0 Units

Racial and ethnic relations in the United States. Examines the cultural, political, and economic practices and institutions that support or challenge racism, racial and ethnic inequalities, as well as patterns of interaction between various racial and ethnic groups. Students who have completed, or are enrolled in, SOC 3 may not receive credit.

Recommended Course Preparation: SOC 1 with a minimum grade of C

FIRE SERVICE TECHNOLOGY

FST 1 FIRE PROTECTION ORGANIZATION 3.0 Units

This course provides an overview to fire protection and emergency services, career opportunities in fire protection and related fields, culture and history of emergency services, fire loss analysis, organization and function of public and private fire protection services, fire departments as part of local government, laws and regulations affecting the fire service; fire service nomenclature, specific fire protection functions, basic fire chemistry and physics, introduction to fire protection systems, introduction to fire strategy and tactics, and life safety initiatives.

FST 2 PRINCIPLES OF FIRE SAFETY 3.0 Units

This course introduces the basic principles and history related to the national firefighter life safety initiatives, focusing on the need for cultural and behavior change throughout the emergency services; assessing fire dangers and handling common fire situations; risk abatement and personal preparation for unforeseen fire emergencies; roles and responsibilities in educating the public on fire safety; development of a survival attitude using problem-solving techniques for increased situational awareness and self-reliance in an emergency.

FST 3 FIRE BEHAVIOR AND COMBUSTION 3.0 Units

Theory and fundamentals of why fires start, spread, and are controlled. An in-depth study of fire chemistry and fire physics, characteristics of materials, extinguishing agents, and fire control techniques.

FST 4 FIRE PREVENTION 3.0 Units

Provides fundamental knowledge relating to the field of fire prevention. Topics include history and philosophy of fire prevention and organization, organization and operation of a fire prevention bureau, use and applications fire codes and standards, plans review, fire inspections, identification and correction of fire hazards, fire and life safety education, and and fire investigation.

Recommended Course Preparation: FST 1 with a minimum grade of C

Scan here to visit the current Spring 2024 class schedule online



FST 5 FIRE PROTECTION SYSTEMS 3.0 Units

This course provides information relating to the features of design, and operations of fire alarm systems, water-based suppression systems, special hazard fire suppression systems and water supply for fire protection, smoke and thermal detection systems. Installation, testing and maintenance of automatic or manual protection systems and water supply for sprinkler and standpipe systems and portable fire extinguishers.

FST 6 CONSTRUCTION FIRE PROTECTION 3.0 Units

This course provides the components of building construction related to fire and life safety. The elements of construction and design of structures are shown to be key factors when inspecting buildings, preplanning fire operations, and operating at fire and collapse emergencies. Development and evolution of building and fire codes will be studied in their relationship to past fires and collapses in residential, commercial, and industrial occupancies.

Recommended Course Preparation: FST 1 with a minimum grade of C

FST 7 FIRE SERVICE CONDITIONING 1.0 Units

This course is an introduction to the components of physical fitness development and conditioning, with an emphasis in preparing students for the physical agility performance and testing standards required of "Emergency First Responder" Candidates entering into Police or Fire Academies. Students will be presented instruction on proper warm-up and stretching techniques, how to maintain and develop the components of fitness through increased muscular strength and muscular endurance, cardiovascular endurance and recovery, and increased flexibility and balance. Students will be introduced to Circuit Training and will also receive skills instruction on various testing parameters of the Nationally approved and recognized Certified Physical Agility Test (CPAT). Students will additionally receive instruction on various "Tools of the Trade" (i.e., Ladder, Fire Hose, SCBA) for developing proper skills in handling, lifting and carrying techniques as well as developing cardio-respiratory control and aerobic conditioning while wearing a "Self Contained Breathing Apparatus" (SCBA) under conditions of physical exertion.

FST 12 ACADEMY- FIREFIGHTER 1 AND 2 17.0 Units

This course provides the skills and knowledge needed for the entry-level firefighter to perform structural suppression activities, wildland fire suppression activities and hazardous materials mitigation and containment activities. This course covers topics in both Firefighter 1 and Firefighter 2 in accordance with the California State Fire Marshall 2019 Curriculum.

Prerequisite: EMS 30 with a minimum grade of C or A valid State of California EMT or PARAMEDIC license issued by the CA EMSA also meet this prerequisite. and FST 1 with a minimum grade of C and FST 7 with a minimum grade of C or A valid CPAT (Candidate Physical Agility Test) or a BIDDLE (Firefighter Physical Agility) test also meet this prerequisite.

FRENCH

FREN 1B ELEMENTARY FRENCH 5.0 Units

This is the second semester of the introductory level course and will enable students to continue to learn to speak, read and write elementary level French as well as to understand the spoken language. Students are introduced to concepts of grammar, vocabulary and verb tenses in a variety of auditory, visual and written contexts.

Prerequisite: FREN 1A with a minimum grade of C or appropriate skill level demonstrated through the assessment process.

GEOGRAPHY

GEOG 1 INTRO TO PHYSICAL GEOGRAPHY 3.0 Units

This course is a spatial study of the Earth's dynamic physical system and processes. Topics include: Earth-sun geometry, weather, climate, water, landforms, soil, and the biosphere with emphasis on spatial characteristics, change over time, interactions between environmental components, and human-environment interactions. Tools of geographic inquiry are also briefly covered; they include maps, remote sensing, Geographic Information Systems (GIS) and Global Positioning Systems (GPS).

GEOG 1L INTRO. PHYSICAL GEOGRAPHY LAB 1.0 Units

This course is designed to provide supplemental exercises in topics covered in physical geography lecture. Lab experience will include map analysis and interpretation, weather prognostication, landform processes and evolution, tectonics, biogeography, and habitat analysis.

Prerequisite: GEOG 1 with a minimum grade of C (may be taken concurrently)

GEOG 2 CULTURAL GEOGRAPHY 3.0 Units

The course is a study of diverse human populations, their cultural origins, diffusion and contemporary spatial expressions. Topics include: demography, languages and religions, urbanization and landscape and religions, urbanization and landscape modification, political units and nationalism, and economic systems and development.

GEOG 5 WORLD REGIONAL GEOGRAPHY 3.0 Units

Survey of the world's culture regions and nations as interpreted by geographers, including physical, cultural, and economic features. Emphasis on spatial and historical influences on population growth, transportation networks, and natural environments. Identification and importance of the significant features of regions.

GEOG 15 INTRODUCTION TO GIS 3.0 Units

Study of Geographic Information Systems (GIS) science and its applications to spatial data management. Identification and acquisition of GIS data. Assessment of vector and raster systems, scale, resolution, map projection, coordinate systems, georeferencing and Global Positioning Systems (GPS). Spatial analysis and modeling with GIS.

GEOLOGY

GEOL 1 PHYSICAL GEOLOGY 3.0 Units

The Earth, its materials, its internal and external processes, and its development through time. Emphasis is placed on a thorough global understanding of Plate Tectonics as a framework and foundation for subsequent geologic topics and concepts. Topics include volcanoes, earthquakes and seismology, the Geologic Time Scale and the formation of the earth, rocks and minerals, hydrology, erosion, beach systems, environmental geology, glaciation, groundwater, etc. Course content includes the difference between theory and fact and the historical development of key geologic concepts. This is the foundation course for almost all subsequent geology courses for both geology majors and non-majors.

GEOL 1L PHYSICAL GEOLOGY LABORATORY 1.0 Units

Laboratory course to supplement the physical geology lecture course. Introduction to the materials and techniques of geology.

Includes minerals, rocks, topographic and geologic maps, structural geology, identification and interpretation of landforms, geologic time and relative age dating analysis, etc.

Prerequisite: GEOL 1 or GEOL 5 or GEOL 7 with a minimum grade of C (May be taken concurrently).

GEOL 2 HISTORICAL GEOLOGY WITH LAB 4.0 Units

An introduction to Earth's history and the life it supports with a laboratory. Subjects include geologic dating, plate tectonics, stratigraphy, fossils, biological evolution, the planet's origin and the processes that have influenced paleogeography during the past 4.6 billion years.

Strongly Recommended: GEOL 1 with a minimum grade of C

GEOL 12 INTRODUCTION TO OCEANOGRAPHY 3.0 Units

Introduction to the oceans, the history of oceanic science, instrumentation and exploration; marine geology including plate tectonics and shoreline processes; physical and chemical properties of sea water; causes and effects of currents, tides, and waves; introduction to the basic types of marine life, the basic marine habitats and ecosystems; distribution of marine resources and the Law of the Sea.

GEOL 12L INTRO TO OCEANOGRAPHY LAB 1.0 Units

Laboratory course to supplement the oceanography lecture course. Introduction to the materials and techniques of oceanic science. Includes sea floor rocks, oceanic geography, bathymetric maps, seismic reflection, seawater physics and chemistry, beach sand, tides, waves, marine life and marine fossils, sea floor spreading rates, etc.

Prerequisite: GEOL 12 (may be taken concurrently).

GLOBAL STUDIES

GS 1 INTRODUCTION TO GLOBAL STUDIES 3.0 Units

This course looks at the economic and political forces that have led to rapid changes in global interaction and culture over the past century, with special emphasis on the last twenty years. It explores the issues of nationalism, global citizenry, state violence, terrorism, the global economy, migration, the threatened environment, technology, and the role of multinational media industries on culture. Students who have completed, or are enrolled in, SOC 5 may not receive credit.

GRAPHIC DESIGN & DIGITAL MEDIA

GDDM 50 GRAPHIC DESIGN/DIGITAL MEDIA 3.0 Units

Introduction to Digital Art and Design Media and their use in the vocations of Graphic Design, Web and Device Design, Information Design, and Digital Art and Photography. An exploration of the methods of conceptual development of visual content and the language of design to direct the use of these digital tools at basic technical level to bring this content to completion in print or on screen.

GDDM 51 COLOR THEORY 3.0 Units

A basic-level course highlighting color as an element for communication and expression in all visual fields. Covers key color systems and their relevance to graphic and other visual arts and creative and technical aspects of color. Students who have completed, or are enrolled in, ARTS 26 may not receive credit.

GDDM 53 PHOTOSHOP I 3.0 Units

Technical and skill development course using the most recent version of Adobe Photoshop at the introductory to create and manipulate digital images, photographs and illustrations. Emphasis on basic to lower-intermediate level techniques and tools used to create image files suitable for print and screen. Design principles emphasized to create effective output through computer-based composition.

Recommended Course Preparation: GDDM 50 and/or GDDM 51 with a minimum grade of C

GDDM 54 ILLUSTRATOR I 3.0 Units

Technical and drawing skill development course using the latest version of Illustrator at the basic- to intermediate- level to render 2- and 3-D digital drawings and illustrations. Emphasis on basic- to intermediate-level techniques and tools used to create image files suitable for print and screen. Design principles emphasized to create effective output through computer-based composition.

Recommended Course Preparation: GDDM 50 with a minimum grade of C

GDDM 58 PHOTOSHOP II 3.0 Units

Technical and design skill development course using Photoshop to create and manipulate images, illustrations, text and animations. Emphasis on intermediate-through advanced-level techniques and tools used to create photo-realistic composites, special effects, custom brushes, and Photoshop rendered imagery for print and screen.

Prerequisite: GDDM 53 with a minimum grade of C

Strongly Recommended: GDDM 50

GDDM 59 ILLUSTRATOR II 3.0 Units

Students in this course will use advanced features in Adobe Illustrator to create a number of illustrations with an emphasis on visual storytelling and development of personal style. Students will learn how to incorporate raster images, apply filters, explore the color guide, and utilize the perspective tool for developing stylistic effects.

Prerequisite: GDDM 54 with a minimum grade of C

GDDM 60 CREATIVE POTFOLIO DEV & PROMO 3.0 Units

Student will develop strategies to promote oneself and one's work. Create and refine a design portfolio and resume to impress potential clients and employers. Practice effective techniques for oral and visual presentations, interviews, and client discussions.

Recommended Course Preparation: GDDM 53, GDDM 54, GDDM 55 and GDDM 64 with a minimum grade of C

HEALTH

HEA 1 INTRO TO PERSONAL HEALTH 3.0 Units

An exploration of major health issues and behaviors in the various dimensions of health (physical, emotional, intellectual/mental, social, spiritual, and environmental). Emphasis is placed on individual responsibility for personal health and the promotion of informed, positive health behaviors. Topics include psychological health, mental health, stress management, nutrition, exercise, weight management, chronic and infectious diseases, healthy relationships,

Scan here to visit the current Spring 2024 class schedule online



sexual health, drug use and misuse, aging, and the health care system.

HEA 3 WOMENS HEALTH 3.0 Units

Physiological, psychological, social, cultural, and political influences on women's health. Emphasis on diversity of women's health experiences and factors involved with both population level health outcomes and individual decision-making. Focus on empowerment for primary prevention.

HEA 7 INTRODUCTION TO PUBLIC HEALTH 3.0 Units

An introduction to the discipline of Public Health including basic concepts and terminologies of public health, as well as the history and accomplishments of public health professionals and agencies. An overview of the functions of various public health professions and institutions, and an in-depth examination of the core public health disciplines will be covered. Topics include epidemiology of infectious and chronic diseases; prevention and control of diseases in the community; analysis of the social determinants of health; health disparities among various populations; strategies for disease reduction; community organizing and health promotion programming; environmental health and safety; global health; and healthcare policy.

Recommended Course Preparation: Eligibility for ENG 1A

HISTORY

HIST 2 WESTERN CIVILIZATION SINCE 1600 3.0 Units

This course traces the history of Western civilization from the 1600s to the present. Topics include the Scientific Revolution, the Enlightenment, and the Industrial Revolution; the American and French Revolutions; World Wars I and II; the Cold War and its end; and the challenges of the modern era.

HIST 3 WORLD HISTORY TO 1500 3.0 Units

Survey of the experience of all peoples with vastly different cultures inhabiting a single globe. Emphasizes the emergence of human communities, formation of complex societies, development of major belief systems and interaction with the environment based on experience, knowledge, and technology to c.1500.

HIST 7 US HIST. THROUGH RECONSTRUCTION 3.0 Units

A survey of United States history from its pre-colonial, indigenous origins through the end of Reconstruction. Emphasis on (1) distinctively American patterns of political, economic, social, intellectual and geographic developments, (2) the interaction amongst and the experiences of diverse racial, ethnic and socioeconomic groups in American History, and (3) the evolution of American institutions and ideals including the U.S. Constitution, the operations of the U.S. government, and the rights and obligations of U.S. citizens under the Constitution.

HIST 8 US HIST. POST-RECONSTRUCTION 3.0 Units

History of the United States from the post-Civil War period to the present. Emphasis on (1) distinctively American patterns of political, economic, social, intellectual and geographic developments, (2) the framework of California state and local government, and the relationship between state/local government and the federal government.

HIST 28 HISTORY OF AMERICAN WEST 3.0 Units

A history of the trans-Mississippi West of the United States. Emphasis will be placed on Native American history and cultures, European and Anglo-American frontiers, expansion of the United States in the 19th century, and the interaction of Native American, European

American, Asian American, African American and Hispanic American peoples, and the significance of the West in American history.

HIST 32 U.S. WOMENS HISTORY 3.0 Units

A survey of United States women's history from its indigenous origins through the present. This course emphasizes the interaction and experiences of diverse racial/ethnic groups that include at least three of the following groups: African-Americans, Chicana/Latina Americans, Asian Americans, European Americans, and Native Americans. Special areas of focus include women's role in the political, economic, social, and geographic development of the United States.

HORTICULTURE

HORT 53 LANDSCAPE/VINEYARD PEST MGT. 3.0 Units

Concepts of plant pathology, entomology, and weed science are studied in order to identify symptoms, diagnose problems, and determine methods of controlling plant diseases, insects, and weed pests. Methods and techniques of integrated pest management, chemical and non-chemical control related to garden, landscape, and other horticulture crops and plants are studied. Disease and pest control materials are assessed with emphasis on safe handling and application, and environmental protection. Focus is on preparation for State Qualified Applicators.

HORT 63 SUSTAINABLE LANDSCAPES 2.0 Units

This course examines the impact of constructed landscapes on the postindustrial society. Natural ecosystems are studied in order to learn concepts essential to create and maintain sustainable, environmentally sound landscapes. The focus of this course is on planning, designing, installing, and maintaining of landscapes, through the use of ecologically sound construction techniques, materials, and systems.

HORT 67 INTERIOR PLANTSCAPES 2.0 Units

Identification, use, propagation, growth, environmental adaptation, ornamental value, and care of container, indoor, and house plants.

HORT 71 HYDROPONICS AND AQUAPONICS 2.0 Units

The ecological design and operation of urban agriculture that covers the fundamental principles of raising fish and vegetable crops in soil-less media.

HUMANITIES

HUMN 2 INTRODUCTION TO FILM STUDIES 3.0 Units

Introduction to film aesthetics, styles, and devices, as well as film theory and critical approaches to film analysis. Overview of film history, in addition to film production, technology, and distribution. Emphasis on diverse responses to the art form of cinema and its impact on contemporary culture.

STUDENTS MAY TAKE HUMANITIES COURSES IN ANY ORDER

HUMN 3 INTRODUCTION TO HUMANITIES 3.0 Units

Introduction to the analysis and appreciation of theater, film, music, poetry, architecture, and the visual arts (e.g. painting and sculpture).

STUDENTS MAY TAKE HUMANITIES COURSES IN ANY ORDER

HUMN 4 GLOBAL CINEMAS 4.0 Units

Global cinema traditions analyzed through historical, political, cultural, commercial, and artistic perspectives. Screenings and

interpretation of representative films from a variety of national and cultural film traditions from around the world, including films from Latin American, U.S., Asian, European, African, and Middle Eastern contexts.

STUDENTS MAY TAKE HUMANITIES COURSES IN ANY ORDER

HUMN 10 AMERICAN ARTS AND IDEAS 3.0 Units

Humanities in the United States. Explored through major works of literature, painting, sculpture, architecture, film, music, philosophy, technology, religion, political and social institutions that reflect the values and meanings of the American cultural experience. Particular attention paid to the experience and contributions of various culture groups (African Americans, Asian-Americans, European-Americans, American Indians, and Latino Americans).

STUDENTS MAY TAKE HUMANITIES COURSES IN ANY ORDER

HUMN 12 CULTURE & THE ARTS II: MODERN WORLD 3.0 Units

A survey of the artistic and intellectual accomplishments of human cultures from High Renaissance to Contemporary Eras, i.e. the Modern World. Emphasis is on the study of modern painting, sculpture, architecture, music, literature, theater, religion, and philosophy from around the globe.

STUDENTS MAY TAKE HUMANITIES COURSES IN ANY ORDER

HUMN 28 WORLD MYTHOLOGY 3.0 Units

Introduction to world mythology, including classical mythology, and the mythic themes recurring in literature, the visual arts, and music. Introduction to the major theories used to evaluate mythology. Exploration of myths about creation, destruction, gods, humans, heroes, tricksters, as well as their origins, variation, historical development, and full expression in ancient times and continued presence in the arts.

STUDENTS MAY TAKE HUMANITIES COURSES IN ANY ORDER

INTERIOR DESIGN

INTD 15 DRAFTING FOR INTERIOR DESIGN 3.0 Units

Provides a working knowledge of tools and techniques for interior architectural drafting. emphasis on lettering, dimensioning floor plans, elevation and sections. Also, covers procedures for developing finished presentational drawings and boards.

INTD 20 HISTORY OF INTERIORS/FURN. 3.0 Units

A survey of the history of interiors and furnishings from Egyptian period to the present. Emphasis on furniture styles and ornamentation.

INTD 25 MATERIALS AND RESOURCES 3.0 Units

Survey of residential and commercial interior furnishings with attention to product knowledge of furniture, textiles, ceramics, glass, metals, plastics and composite materials. Skills needed to perform related activities.

JOURNALISM AND MEDIA STUDIES

JAMS 2 INTRODUCTION TO MEDIA 3.0 Units

A survey of radio, television, film, and multimedia and their impact on culture and society; includes economics, technological development, programming, ratings, legal aspects, and social control of broadcasting in America, and cross-cultural, international comparisons.

Recommended Course Preparation: Eligibility for ENG 1A/1AEX

JAMS 11 REPORTING AND NEWSWRITING 3.0 Units

An introduction to gathering, synthesizing/ organizing, and writing news in journalistic style across multiple platforms. Includes role of the journalist, analysis of exemplary journalistic models, and related legal and ethical issues. Students will report and write based on their original interviews and research to produce news content. Experiences may include covering speeches, meetings, and other events, writing under deadline and use of AP Style.

Recommended Course Preparation: Eligibility for ENG 1A/1AEX

JAMS 19A ARTS, LITERATURE, AND WRITING A 3.0 Units

Creation of a literary-style student magazine. Practical training in the managing, editing, formatting, and printing of a literary magazine. Enrollment constitutes the staff of the magazine. Students who have completed, or are enrolled in, ENG 19A may not receive credit.

JAMS 19B ARTS, LITERATURE, AND WRITING B 3.0 Units

Creation of a literary-style student magazine. Practical intermediate-level training in the managing, editing, formatting, and printing of a literary supplement and/or magazine with a focus on the production process, including copy editing, design, layout, proofreading, working with the printer, and digital and print distribution. Enrollment constitutes the staff of the magazine. Students who have completed, or are enrolled in, ENG 19B may not receive credit.

Prerequisite: JAMS 19A or ENG 19A with a minimum grade of C

JAMS 21A EXPRESS COLLEGE NEWSPAPER A 3.0 Units

An applied course in which students practice and refine beginning journalism skills, including recognizing, acquiring, producing, and distributing content for the print and online editions of the student newspaper, the Express. The focus of study is on basic news, feature, and opinion stories. Students are introduced to concepts related to photojournalism, business management, graphic arts, design, social media, and leadership and editing skills. The course includes ethical, practical, and legal issues in journalism.

Recommended Course Preparation: Eligibility for ENG 1A/1AEX

JAMS 21B EXPRESS COLLEGE NEWSPAPER B 3.0 Units

An applied course in which students practice and refine intermediate journalism skills, including recognizing, acquiring, producing, and distributing content for the print and online editions of the student newspaper, the Express. Focus is on in-depth news, feature and opinion stories. Students develop intermediate abilities in photojournalism, business management, graphic arts, design, social media, and leadership and editing skills. The course includes ethical, practical, and legal issues in journalism.

*Recommended Course Preparation: Eligibility for ENG 1A/1AEX
Prerequisite: JAMS 21A with a minimum grade of C*

JAMS 21C EXPRESS COLLEGE NEWSPAPER C 3.0 Units

An applied course in which students practice and refine advanced journalism skills, including recognizing, acquiring, producing, and distributing content for the print and online editions of the student newspaper, the Express. Focus is on leadership, editing the work of others, improving writing and multimedia skills, and improving the Express. Enhanced leadership role includes outreach to the community and representation as journalist and leader at events. Students develop advanced abilities in writing, photojournalism, business management, graphic arts, design, social media, and leadership and editing skills. Students will produce newscasts,

Scan here to visit the current Spring 2024 class schedule online



an infographics, and reader surveys. The course includes ethical, practical, and legal issues in journalism. Students should serve in a leadership role.

Prerequisite: JAMS 21B with a minimum grade of C

JAMS 21D EXPRESS COLLEGE NEWSPAPER D 3.0 Units

An applied capstone course in which students practice and refine advanced journalism skills, including recognizing, acquiring, producing, and distributing content for the print and online editions of the student newspaper, the Express. Focus is on completing a portfolio project, exploring career opportunities in the field, leading others, editing the work of others, improving writing and multimedia skills, and improving the Express. Students work to develop advanced abilities in writing, photojournalism, business management, graphic arts, design, social media, leadership, and editing skills. The course includes ethical, practical, and legal issues in journalism. Student assumes a leadership role and create workshops to benefit other staff members.

Prerequisite: JAMS 21C with a minimum grade of C

JAMS 22 EXPRESS EDITORIAL BOARD 1.0 Units

The roles and responsibilities of leaders on the college newspaper, the Express. Practical experience participating in editorial board meetings, setting policy for the newspaper, and leading in the decision-making process for issue planning, budgeting, and the development of the newspaper. Enrollment is limited to student leaders on the Express.

Recommended Course Preparation: Eligibility for ENG 1A/1AEX

**KINESIOLOGY
- ACTIVITY COURSES -**

KIN BD1 BADMINTON 1 1.0 Units

Introduction to the fundamental techniques of badminton (for example, the forehand and backhand serve, service return, and lob shots). Course will also include grip, footwork, rules, equipment and court dimensions.

KIN BD2 BADMINTON 2 1.0 Units

The techniques of badminton for the intermediate player will be reviewed and performed. This course will also incorporate match analysis for singles and doubles play.

Recommended Course Preparation: KIN BD1 with a minimum grade of C

KIN BD3 BADMINTON 3 1.0 Units

Badminton strategy for singles and doubles play. The body's physiological responses to singles and doubles play will be examined.

Recommended Course Preparation: KIN BD2 with a minimum grade of C

KIN BL1 BOWLING 1 1.0 Units

This course is designed to give the student the opportunity to learn the basic skills, terminology, and etiquette of bowling and be able to participate in a league type bowling program using off-campus bowling centers.

KIN BL2 BOWLING 2 1.0 Units

This course teaches the fundamental skills of bowling with emphasis on form, terminology and scoring. The student will have the opportunity for class competition. The class will be conducted at an off campus bowling establishment.

Recommended Course Preparation: KIN BL1 with a minimum grade of C

Facility use fee required, to be paid throughout the semester at the facility.

KIN BL3 BOWLING 3 1.0 Units

This course teaches intermediate skills of bowling with emphasis on etiquette, terminology and equipment. The student will have the opportunity for class competition. The class will be conducted at an off campus bowling establishment.

Recommended Course Preparation: KIN BL2 with a minimum grade of C

Facility use fee required, to be paid throughout the semester at the facility.

KIN BL4 BOWLING 4 1.0 Units

This course teaches advanced skills of bowling with emphasis on form, rules, and etiquette. The student will have the opportunity for class competition. The class will be conducted at an off campus bowling establishment.

Recommended Course Preparation: KIN BL3 with a minimum grade of C

Facility use fee required, to be paid throughout the semester at the facility.

KIN FJW1 FITNESS JOG WALK 1 1.0 Units

This course is an introduction to a cardiovascular activity that will benefit anyone, regardless of age or fitness level. Individualized walking programs are designed to promote general overall fitness. Jogging and walking capabilities will be enhanced as a result of the exercise undertaken and the cardiovascular training related assignments.

KIN FJW2 FITNESS JOG WALK 2 1.0 Units

This is a progressive continuation course to Fitness Jog Walk 1. Biomechanical analysis and fundamental principles of training for this activity will be reviewed. Basic exercise physiology will be discussed. The student will be given training regimens to increase their pace, speed, distance and endurance for middle distances (e.g 5K - 10K). Nutritional requirements and dietary advice will be presented. Student training logs will be employed to document performance. Pre and post walk/jog assessments will be conducted to establish a baseline of conditioning and illustrate performance levels.

Recommended Course Preparation: KIN FJW1 with a minimum grade of C

KIN FJW3 FITNESS JOG WALK 3 1.0 Units

This is a progressive continuation course to Fitness Jog Walk 2. The course will continue to enhance one's knowledge of using walking/jogging in competition, whether it be cross country events, local race events, fun runs or competitive recreational events. Emphasis will be on speed work, terrain training, endurance development and training for varying outdoor weather conditions. The physiological and psychological aspects of competitive activity is presented. Training regimens and performances will be documented in logs for assessment and training adjustments. Nutritional and treatment of typical chronic orthopedic injuries will be discussed. Extracurricular and off campus events will be encouraged.

Recommended Course Preparation: KIN FJW2 with a minimum grade of C

KIN FJW4 FITNESS JOG WALK 4 1.0 Units

This is a progressive continuation course to Fitness Jog Walk 3. This course focuses on walking and/or jogging to enhance one's cardiovascular fitness, body composition, and overall general health. This course is ideal for the general population to begin or continue a lifetime of exercise. Walking/Jogging techniques, training intensity assessment, methods for improvement and personal programs will be provided during the course. With consistent practice and implementing sound fitness principles provided by this course, one will benefit from participation. Proper jog/walk technique, progressive training programs, nutrition, hydration, and injury prevention will be addressed.

Recommended Course Preparation: KIN FJW3 with a minimum grade of C

KIN GBW1 GUTS AND BUTTS WORKOUT 1 1.0 Units

This course will focus on improving muscle strength and endurance of the abdominals, gluteals, quadriceps, and hamstrings. Functional exercises such as squats, lunges and planks will be utilized.

KIN GBW2 GUTS AND BUTTS WORKOUT 2 1.0 Units

This course will focus on strengthening the core and glute muscles. Students will learn how to use equipment such as steps, TRX, swiss balls, and dumbbells to increase exercise intensity.

Recommended Course Preparation: KIN GBW1 with a minimum grade of C

KIN GF1 GOLF 1 1.0 Units

This is an introductory course to the sport of golf. The course will include the rules, regulations and etiquette of golf, the fundamental swing skills for the long and short game and appropriate club selection. Beg-Intermediate and Intermediate players can benefit from the basic instruction to improve their skill set through the art of practice on the range. The course will be offered at a local golf range.

Student will be charged a minimal fee for bucket of balls to be used.

KIN GF2 GOLF 2 1.0 Units

For students who possess the rudimentary skills of golf and aim to improve those abilities. Students will hone their putting, short game, mid-long iron play and driving capabilities. The course is offered at a local driving range.

Recommended Course Preparation: KIN GF1 with a minimum grade of C.

Student will be charged a minimal fee for bucket of balls to be used.

KIN GF3 GOLF 3 1.0 Units

Advanced technical aspects of golf match play will be included. Additionally, psychological skills for the elite golfer will be incorporated including visualization, pre-shot routines, relaxation methods and self-talk strategies.

Recommended Course Preparation: KIN GF2 with a minimum grade of C.

KIN GF4 GOLF 4 1.0 Units

This course will provide elite golfers with a detailed technical appreciation of the game. Furthermore, a psychological analysis of self-efficacy, arousal regulation, concentration and focus will be applied to golf.

KIN S11 SOCCER - INDOOR 1 1.0 Units

Students will practice the skills of kicking, passing, trapping and heading necessary for controlled indoor soccer play. Students will discuss and employ basic offensive and defensive strategies and tactics; and put into practice the rules governing soccer.

KIN S12 SOCCER - INDOOR 2 1.0 Units

A second semester course for outdoor soccer. This course will focus on the defensive and offensive tactics of the sport. Students will use the skills covered in Indoor Soccer 1 (S11) while participating in both small sided and full sided play.

Recommended Course Preparation: KIN S11 with a minimum grade of C

KIN SO1 SOCCER - OUTDOOR 1 1.0 Units

This course will teach students the rules of soccer and the fundamental skills of soccer including passing, receiving, shooting, and dribbling. Students will participate in both small-sided and full-sided play.

KIN SO2 SOCCER - OUTDOOR 2 1.0 Units

A second semester course for outdoor soccer. This course will focus on the defensive and offensive tactics of the sport. Students will use the skills covered in Soccer - Outdoor 1 (SO1) while participating in

both small sided and full sided play.

Recommended Course Preparation: KIN SO1 with a minimum grade of C

KIN SWF1 SWIMMING FOR FITNESS 1 1.0 Units

This course is designed to introduce students to conditioning for swimming. This is a broad level course that will utilize a variety of strokes to increase cardiovascular fitness, as well as introduce the students to different training methodologies.

Recommended Course Preparation: KIN SW2

KIN SWF2 SWIMMING FOR FITNESS 2 1.0 Units

This is an intermediate level swim fitness course with an emphasis in sprint training. This course will teach the student about the different aspects of sprint training as they relate to different distances (50 and 100 yards/meters). Instruction will also include sprint training for each of the competitive strokes (backstroke, breaststroke, and butterfly).

Recommended Course Preparation: KIN SWF1, KIN SW3

KIN SWF3 SWIMMING FOR FITNESS 3 1.0 Units

This is an intermediate level swim fitness course with an emphasis in middle distance training. This course will teach the student about the different aspects of middle distance training for freestyle as they relate to specific race distances: 200, 400, and 500. Instruction will also focus on the 200 & 400 Individual Medley and the 200's of the strokes (backstroke, breaststroke, and butterfly).

Recommended Course Preparation: KIN SWF1 and KIN SW3

KIN SWF4 SWIMMING FOR FITNESS 4 1.0 Units

This is an intermediate level swim fitness course with an emphasis in distance training. This course will teach the student about the different aspects of distance training for freestyle as they relate to specific race distances: 800/1500 meters and 1000/1650 yards. Instruction will also include an introduction to open water swimming techniques and strategies.

Recommended Course Preparation: KIN SWF1 and KIN SW3

KIN VB1 VOLLEYBALL BEGINNING 1.0 Units

Provides instruction on the individual and team skills and strategies of volleyball.

KIN VB2 VOLLEYBALL INTERMEDIATE 1.0 Units

This is a course designed and developed for the intermediate level volleyball player. It is a continuation of beginning volleyball with an emphasis in executing the fundamental skills and techniques of power volleyball at a higher level. This course differs from beginning volleyball in that set patterns and systems of offense and defense are used in a team strategy.

Recommended Course Preparation: KIN VB1 with a minimum grade of C

BEFORE ENROLLING student should have proficiency in the skills of passing and setting.

KIN VB3 VOLLEYBALL ADVANCED 1.0 Units

Advanced techniques of volleyball with emphasis on competitive play.

Recommended Course Preparation: KIN VB2 with a minimum grade of C

KIN WT1 WEIGHT TRAINING 1 1.0 Units

This course provides an introduction to weight training. Students will learn how to improve muscle strength and muscle endurance through the correct application of basic weight training principles.

Scan here to visit the current Spring 2024 class schedule online



KIN WT2 WEIGHT TRAINING 2 1.0 Units

Weight Training 2 is a continuation course to the Basic course WTW1. The Principles of Training, Level 2 terminology and weight training biomechanics will be presented. Level 2 programs and possible variations will be applied in the prescription of the personal weight training program. The course will incorporate lectures on possible injuries and prevention in a more advanced weight training setting. Implementation of goal setting, tracking, analyzing, progressing individual programs will be included.

Recommended Course Preparation: KIN WT1 with a minimum grade of C

KIN WTW1 WOMENS WEIGHT TRAINING 1 1.0 Units

This specialized course will provide an orientation to the basic weight training machines available in gyms/clubs and proper gym etiquette, a study of the basic musculoskeletal anatomy and kinesiology of the female body, present the fundamental tenets of weight training, discuss how to maintain healthy body composition, and information on designing a weight training program to achieve attainable personal goals. Pre/Post Fitness Assessments will be conducted to establish a baseline of fitness and a measuring instrument for improvement toward weight training goals. Through proper education and implementation of sound weight training principles, the female student will be able to maintain a healthy lifestyle throughout various stages of life.

KIN WTW2 WOMENS WEIGHT TRAINING 2 1.0 Units

Women's Weight Training 2 is a continuation course to Women's Weight Training 1. Students will increase muscular strength and/or muscular endurance using weight machines, free weights, and body weight exercises. Implementation of program design and goal setting will be included.

Recommended Course Preparation: KIN WTW1 with a minimum grade of C.

KIN YO1 YOGA 1 1.0 Units

This is an introductory course exploring the principles of Hatha Yoga and how they apply to achieving lifetime fitness. Emphasis is on developing awareness of body alignment, balance, and flexibility through a series of exercises and poses. Breathing exercises, relaxation and meditation techniques are learned and practiced throughout the course.

KIN YO2 YOGA 2 1.0 Units

This is an intermediate Hatha Yoga course that emphasizes intense stretching, balancing, and building of muscular strength. A series of poses and breathing techniques will be practiced in order to create a more strenuous yoga experience. Emphasis will be on the principles of healthy living, along with proper posture, relaxation and meditation techniques.

Recommended Course Preparation: KIN YO1 with a minimum grade of C

KIN YO3 YOGA 3 1.0 Units

This is an intermediate/advanced Hatha Yoga course that introduces the student to a variety of Yoga styles and meditation practices. Gentle, Restorative, and Vinyasa Yoga along with various meditation techniques will be practiced, improving concentration, physical endurance, flexibility, balance, and posture. The course integrates intermediate breathing techniques to deepen the level of introspection in both poses and meditation. Basic Sanskrit terminology will be introduced. Emphasis will be placed on mindfulness and strengthening the mind/body connection.

Recommended Course Preparation: KIN YO1 and KIN YO2 with a minimum grade of C

KIN YO4 YOGA 4 1.0 Units

This course introduces the student to the advanced practice of Yoga and meditation. Students learn the practice of vigorous Vinyasa flow

to improve concentration, physical endurance, flexibility, balance and posture. This course integrates Yoga philosophy and advanced breathing techniques to deepen the mind/body connection and reduce stress.

Prerequisite: KIN YO3 with a minimum grade of C

KIN YIN1 YIN YOGA 1 1.0 Units

This course is an introduction to the practice of Yin Yoga. Yin Yoga is a meditative, therapeutic practice that combines slow dynamic movement with longer static holds. Yin poses are held for 3-5 minutes, cultivating mindfulness, introspection, and the deeper aspects of Yoga. Longer hold times stimulate connective tissue, signaling the body to create more resilient ligaments, joints, deep fascial networks and bones. Appropriate for all levels.

KIN ZUM1 ZUMBA FITNESS WORKOUT 1 1.0 Units

Zumba is a Latin-inspired, dance-fitness workout class that incorporates Latin American inspired music, along with jazz, hip hop, pop, country and African inspired international music. Zumba workouts will use choreographed steps and movements to form a fitness based calorie burning dance workout.

**KINESIOLOGY
- INTERCOLLEGIATE ATHLETICS -**

KIN 32B SPRING INTERCOLL. MEN'S BBALL 3.0 Units

Basketball training for intercollegiate competition. Daily practice for advanced skill learning will occur. Spring semester.

KIN 38C POST SEASON INTER.MENS SOCCER 2.0 Units

Students will learn and develop the advanced outdoor soccer skills of kicking, passing and conditioning necessary for playing field soccer at an intercollegiate level. Students will learn the rules governing outdoor soccer play.

KIN 40C OFF SEASON WOMENS VOLLEYBALL 1.0 Units

Designed to provide a physical, mental, nutritional and instructional conditioning program for the student preparing for and/or interested in being evaluated for the intercollegiate sport of women's volleyball. Strongly Recommended: KIN 40B with a minimum grade of C

KIN 41C SPRING INTERC.BASKETBALL-WOMEN 1.5 Units

Training for intercollegiate competition. Daily practice. Spring semester.

KIN 41D OFF SEASON WOMENS BASKETBALL 1.5 Units

Students will practice the skills of dribbling, passing, shooting and defense necessary for competitive basketball play; put into practice the governing rules of basketball; learn about the appropriate terminology used in basketball and the safety procedures related to the game.

KIN 48C OFF SEASON WOMENS SOCCER 2.0 Units

Students will practice the skills of kicking, passing, trapping and heading necessary for controlled outdoor soccer play; put into practice the rules governing outdoor soccer play; learn about the appropriate terminology used in soccer and the safety procedures related to the soccer game.

KIN 50B INTERCOLL. SWIMMING & DIVING 3.0 Units

This course is for intercollegiate swimming and diving competition conducted through the NCAA and the CCCAA.

Recommended Course Preparation: KIN SW3 and KIN SWF1 with a minimum grade of C

KIN 61B OFF SEASON INTERCOL. WATER POLO 1.0 Units

This course is designed to give students the opportunity to learn and apply specific conditioning skills relating to the game of Water Polo. Instruction will focus on speed, quickness, strength, and cardiovascular conditioning in the pool as they relate to the play of Water Polo. Concepts of dryland training and periodization will be discussed.

Recommended Course Preparation: KIN WP1 and KIN SW2 with a minimum grade of C

KINESIOLOGY - THEORY COURSES -

KIN 6 PERSONAL TRAINER 3.5 Units

This course emphasizes the theoretical and hands on skills required of personal trainers, coaches and fitness professionals. This course will bridge the gap between exercise science, kinesiology and practical hands-on learning by integrating the latest in scientific and physiologically based research. This class will have lectures, labs, group work/discussions and assignments.

KIN 14 RESPONDING TO EMERGENCIES: 3.0 Units

This course involves the theory and detailed demonstration of the first aid care of the injured. The student will learn to assess a victim's condition and incorporate proper treatment. Standard first aid, CPR, and AED certification(s) will be granted upon successful completion of requirements.

KIN 16 THE SUCCESSFUL STUDENT ATHLETE 1.0 Units

This course is designed to assist the student-athlete in developing realistic expectations and goals of college, explore academic programs, and understand what is necessary to succeed in college while competing in an intercollegiate sport. This course will also discuss the probability of becoming a professional athlete and life after athletics. The rules and regulations of the California Community College Athletic Association (CCCAA), National Intercollegiate Athletic Association (NCAA), and the National Association of Intercollegiate Athletics (NAIA) will be defined and explored to bring awareness to the student-athlete regarding eligibility and transferring to a four-year institution.

KIN 17 INTRO ATHLETIC TRNG/SPORTS MED 4.0 Units

Basic taping skills, introduction to modality usage, and basic rehabilitation principles of athletic training. Designed to be preparatory for further education and a career in Athletic Training and or other Sports Medicine related fields. May include work with intercollegiate sports programs. Legal and ethical issues, professionalism, organization and administration of a sports medicine facility. This course is focused on preparing those interested in becoming Athletic Trainers and Coaches.

KIN 18A ATHLETIC TRAINING PRACTICUM 1 1.0 Units

Designed to provide clinical experience for students interested in sports-related injury care and prevention. Organization of a clinical facility and management of game day operations. Experiences will include taping for prevention of injury, use of modalities for the treatment and/or rehabilitation of injuries, stretching techniques, identify and manage emergency situations.

Prerequisite: KIN 17 with a minimum grade of C

KIN 18B ATHLETIC TRAINING PRACTICUM 2 1.0 Units

This course will expose students to injury evaluation, methods of diagnosis and rehabilitation. The student will help make return to play decisions based on the knowledge they have learned in their

coursework. The students will develop and administer conditioning programs to Las Positas College athletes with the guidance of the Certified Athletic Trainer.

Prerequisite: KIN 18A with a minimum grade of C

KIN 19 CARE & PREVENTION OF INJURIES 3.0 Units

This course provides an introduction to the principles and scientific foundations of athletic training. Examination in the techniques used in the prevention of athletic injuries, including taping, bandaging, and strapping along with how to recognize and evaluate basic signs and symptoms associated with common injuries. Establishing a plan of care that includes rehabilitative exercise will also be studied. Legal and ethical issues, professionalism, organization and administration of a sports medicine facility. This course is focused on preparing those interested in becoming Athletic Trainers and Coaches.

Prerequisite: KIN 17 with a minimum grade of C

KIN 24 SPORT PSYCHOLOGY 3.0 Units

A formal introduction to the study of sport psychology focusing upon both the psychological factors that influence participation in sport and exercise and the psychological effects derived from that participation. Emphasis on understanding the psychological processes involved in human performance, models of intervention that can enhance and improve learning and performance conditions, and the strategies which can elicit and influence favorable psychological perceptions and outcomes.

KIN 30 INTRODUCTION TO KINESIOLOGY 3.0 Units

This class is designed to introduce the student to Kinesiology - the science of human movement (and of humans moving). Concepts in the various subfields of Kinesiology are examined and career opportunities in the field of Kinesiology are explored. Due to the interdisciplinary nature of Kinesiology, the field will be covered from a humanities, social science, and life science perspective.

LGBT STUDIES

LGBT 1 INTRO TO LGBTQ STUDIES 3.0 Units

A broad exploration of queer theory and its relationship to gay and lesbian studies, feminist theory, and intersectionality. Emphasis on theoretical and philosophical underpinnings of queer theory, social construction and essentialism, postmodernist theory, politics, LGBT studies and queer culture. Examines LGBTQ issues from psychological, bio-medical, sociological, political, racial and sexual perspectives.

LIBRARY SKILLS

LIBR 4 COLLEGE RESEARCH TECHNIQUES 0.5 Units

Introduction to basic research techniques in a college library. Focus on use of the library catalog, search strategies, organization of materials in the library including reference, faculty reserves, circulating books, audiovisuals, use of reference materials, evaluation of relevant resources, recognition of plagiarism, and bibliographic citation of books, audiovisuals, and magazines and journals.

Scan here to visit the
current Spring 2024
class schedule online



LIBR 7 THE OPEN WEB & SEARCH ENGINES 0.5 Units
 Introduction to research techniques in a college library using search engines to find materials on the open web. Focus on use of the open web for research purposes, including web search strategies, appropriate search engines and directories, evaluation techniques for web resources, recognition of plagiarism, and bibliographic citation of web resources.

MARKETING

MKTG 50 INTRODUCTION TO MARKETING 3.0 Units
 Marketing as a value exchange process involving all societal members; an overview of product development, pricing, placement, and promotion; Target markets including the demographic and behavioral dimensions of markets; analyses of marketing placement and pricing strategies and the social, cultural, economic, competitive and legal factors affecting marketing mix decisions.

Recommended Course Preparation: Eligibility for college-level composition (ENG 1A, ENG 1AEX, or ESL 1A) as determined by college assessment or other appropriate method

MKTG 56 MARKETING STRATEGIES 3.0 Units
 Current marketing trends, strategies, and techniques. Introduction to online and social media marketing. The promotional process and techniques in the development of effective content creation and branding. Advanced theories, principles, and practices of customer service, customer loyalty, and the customer experience.

MATH

- **Math Emporium**.....pg. 48
- **Lecture Courses**pg. 49
- **Concurrent Support**pg. 50
- **Math Jam**.....pg. 50
- **NonCredit Concurrent Support**.....pg. 56
- **NonCredit Math Jam**pg. 57

MATH - MATH EMPORIUM -

The Math Emporium is a mode in which students have the ability to complete their transferrable math courses in a personalized mode. This mode allows students to self-accelerate through the material in a way that is unique to each student's needs. Students will decide when they are ready to take a test.

For more information including technology requirements, go to the Mathematics Department website at <http://www.laspositascollege.edu/mathemporium>

MATH 30 COLLEGE ALGEBRA FOR STEM 4.0 Units
 College algebra core concepts relating to Science, Technology, Engineering and Mathematics (STEM) and Business fields are explored, such as: polynomial, rational, radical, exponential, absolute value, and logarithmic functions; systems of equations; theory of polynomial equations; and analytic geometry. Multiple

representations, applications and modeling with functions are emphasized throughout.

Prerequisite: Intermediate Algebra or a higher level of mathematics.

Some sections of this course are taught in the Math Emporium, which is a self-paced, instructor guided, independent learning mode. Dates and times of exams are semi-flexible as they are based on a student's progress through the course material. For more information including technology requirements, go to the Mathematics Department website at <http://www.laspositascollege.edu/mathemporium>.

Students are strongly encouraged to also enroll in a tuition-free, noncredit NMAT 201C or a 1-unit credit Math 101C for individualized, interactive support in College Algebra.

A TI-84 or TI-83 calculator may be required for some sections of this course.

MATH 39 TRIGONOMETRY 4.0 Units
 Trigonometry includes definitions of the trigonometric functions and their inverses, graphs of the trigonometric functions and their inverses, trigonometric equations, trigonometric expressions and identities, including proofs, an introduction to vectors, polar coordinates and complex numbers. Applications include solving right triangles and solving triangles using the law of sines and the law of cosines.

Prerequisite: Intermediate Algebra or a higher level of mathematics.

Some sections of this course are taught in the Math Emporium, which is a self-paced, instructor guided, independent learning mode. Dates and times of exams are semi-flexible as they are based on a student's progress through the course material. For more information including technology requirements, go to the Mathematics Department website at <http://www.laspositascollege.edu/mathemporium>.

MATH 40 STATISTICS AND PROBABILITY 4.0 Units
 Descriptive statistics, including measures of central tendency, dispersion and position; elements of probability; confidence intervals; hypothesis tests; two-population comparisons; correlation and regression; goodness of fit; analysis of variance; applications in various fields. Introduction to the use of a computer software package to complete both descriptive and inferential statistics problems.

Prerequisite: Intermediate Algebra or a higher level of level of mathematics.

Some sections of this course are taught in the Math Emporium, which is a self-paced, instructor guided, independent learning mode. Dates and times of exams are semi-flexible as they are based on a student's progress through the course material. For more information including technology requirements, go to the Mathematics Department website at <http://www.laspositascollege.edu/mathemporium>.

A TI-84 or TI-83 calculator may be required for some sections of this course.

MATH 47 MATHEMATICS FOR LIBERAL ARTS 3.0 Units
 An introduction to a variety of mathematical concepts for students interested in liberal arts. Intended to cultivate an appreciation of the significance of mathematics in daily life and help develop students' mathematical reasoning. Topics include personal finance, probability and statistics, logic, exponential growth, and graph theory.

Prerequisite: Intermediate Algebra or a higher level of mathematics.

Some sections of this course are taught in the Math Emporium, which is a self-paced, instructor guided, independent learning mode. Dates and times of exams are semi-flexible as they are based on a student's progress through the course material. For more information including technology requirements, go to the Mathematics Department website at <http://www.laspositascollege.edu/mathemporium>.

A TI-84 or TI-83 calculator may be required for some sections of this course.

MATH - LECTURE COURSES -

Classes taken in lecture mode are guided by the instructor. Refer to the online schedule for details on each course's requirements.

Students may be required to purchase internet-based software for some math classes. For more information, see the section titled "Online Learning" in this schedule, or go to <http://www.laspositascollege.edu/onlinelearning>.

A TI-84 or TI-83 calculator or internet-based software may be required for some sections of a course. There may be a fee associated with these materials. Consult with the instructor or bookstore before registering for this course.

MATH 1 CALCULUS I 5.0 Units

An introduction to single-variable differential and integral calculus including: functions, limits and continuity; techniques and applications of differentiation and integration; the Fundamental Theorem of Calculus; areas and volumes of solids of revolution.

Prerequisite: MATH 30 and MATH 39 or MATH 38 with a minimum grade of C

MATH 2 CALCULUS II 5.0 Units

Continuation of single-variable differential and integral calculus. Topics covered include: inverse and hyperbolic functions; techniques of integration; polar and parametric equations; infinite sequences, series, power series and Taylor series; applications of integration. Primarily for mathematics, physical science and engineering majors.

Prerequisite: MATH 1 with a minimum grade of C

MATH 3 MULTIVARIABLE CALCULUS 5.0 Units

Vector valued functions, functions of several variables, partial differentiation, multiple integration, change of variables theorem, scalar and vector fields, gradient, divergence, curl, line integral, surface integral, Green's Stokes' and divergence theorem, applications.

Prerequisite: MATH 2 with a minimum grade of C

A TI-84 or TI-83 calculator or internet-based software may be required for some sections of this course. There may be a fee associated with these materials.

MATH 5 ORDINARY DIFFERENTIAL EQUATION 3.5 Units

Introduction to differential equations including the conditions under which a unique solution exists, techniques for obtaining solutions, and applications. Techniques include generation of series, solutions, use of Laplace Transforms, and the use of eigenvalues to solve linear systems. Generation of exact solutions, approximate solutions, and graphs of solutions using MATLAB.

Prerequisite: MATH 3 with a minimum grade of C

MATH 7 ELEMENTARY LINEAR ALGEBRA 3.5 Units

An introduction to linear algebra including: techniques and theory needed to solve and classify systems of linear equations using Gaussian elimination and matrix algebra; properties of vectors in n-dimensions; generalized vector spaces, inner product spaces, basis, norms, orthogonality; eigenvalues, eigenspaces; and linear transformations. Selected applications of linear algebra, including the use of MATLAB to solve problems involving advanced numerical computation.

Prerequisite: MATH 2 with a minimum grade of C

MATH 10 DISCRETE MATHEMATICS 4.0 Units

Designed for majors in mathematics and computer science, this course provides an introduction to discrete mathematical structures

used in Computer Science and their applications. Course content includes: Propositional and predicate logic; rules of inference; quantifiers; elements of integer number theory; set theory; methods of proof; induction; combinatorics and discrete probability; functions and relations; recursive definitions and recurrence relations; elements of graph theory and trees. Applications include: analysis of algorithms, Boolean algebras and digital logic circuits. Students who have completed, or are enrolled in, CS 17 may not receive credit.

Prerequisite: MATH 1 and CS 1 with a minimum grade of C (May be taken concurrently)

MATH 27 NUMBER SYSTEMS FOR EDUCATORS 3.0 Units

This course focuses on the development of quantitative reasoning skills through in-depth, integrated explorations of topics in mathematics, including real number systems and subsystems. Emphasis is on comprehension and analysis of mathematical concepts and applications of logical reasoning.

Prerequisite: Intermediate Algebra or a higher level of mathematics.

Students are strongly encouraged to enroll in a tuition-free noncredit NMAT 200C or a 1-unit credit Math 100C for individualized, interactive support. For more information on math supports please visit: <https://www.laspositascollege.edu/math/mathjam.php>

A TI-84 or TI-83 calculator or internet-based software may be required for some sections of this course. There may be a fee associated with these materials. Consult with the instructor or bookstore before registering for this course.

MATH 30 COLLEGE ALGEBRA FOR STEM 4.0 Units

College algebra core concepts relating to Science, Technology, Engineering and Mathematics (STEM) and Business fields are explored, such as: polynomial, rational, radical, exponential, absolute value, and logarithmic functions; systems of equations; theory of polynomial equations; and analytic geometry. Multiple representations, applications and modeling with functions are emphasized throughout.

Prerequisite: Intermediate Algebra or a higher level of mathematics.

Students are strongly encouraged to enroll in a tuition-free, noncredit NMAT 201C or a 1-unit credit Math 101C for individualized, interactive support in College Algebra.

A TI-84 or TI-83 calculator or internet-based software may be required for some sections of this course. Materials may be borrowed from the LPC Library or purchased in the bookstore.

MATH 33 FINITE MATHEMATICS 4.0 Units

Linear functions, systems of linear equations and inequalities, exponential and logarithmic functions and applications, matrices, linear programming, mathematics of finance, sets and Venn diagrams, combinatorial techniques and an introduction to probability. Applications in business, economics and social sciences.

Prerequisite: Intermediate Algebra or a higher level of mathematics.

Students are strongly encouraged to enroll in a tuition-free, noncredit NMAT 200C or a 1-unit credit Math 100C for individualized, interactive support. For more information on math supports please visit: <https://www.laspositascollege.edu/math/mathjam.php>

A TI-84 or TI-83 calculator or internet-based software may be required for some sections of this course. There may be a fee associated with these materials. Consult with the instructor or bookstore before registering for this course.

MATH 34 BUSINESS CALCULUS 4.0 Units

Functions and their graphs; limits of functions; differential and integral calculus of algebraic, exponential and logarithmic functions. Applications in business, economics, and social sciences and use

Scan here to visit the
current Spring 2024
class schedule online



of graphing calculators. Partial derivatives and the method of Lagrange multipliers.

Prerequisite: Intermediate Algebra or a higher level of mathematics.

Students are strongly encouraged to enroll in a tuition-free, noncredit NMAT 201C or a 1-unit credit Math 101C for individualized, interactive support in Business Calculus. For more information on math supports please visit: <https://www.laspositascollege.edu/math/mathjam.php>

A TI-84 or TI-83 calculator or internet-based software may be a fee associated with these materials. Consult with the instructor or bookstore before registering for this course.

MATH 39 TRIGONOMETRY 4.0 Units

Trigonometry includes definitions of the trigonometric functions and their inverses, graphs of the trigonometric functions and their inverses, trigonometric equations, trigonometric expressions and identities, including proofs, an introduction to vectors, polar coordinates and complex numbers. Applications include solving right triangles and solving triangles using the law of sines and the law of cosines.

Prerequisite: Intermediate Algebra or a higher level of mathematics.

Students are strongly encouraged to enroll in a tuition-free, noncredit NMAT 201C or a 1-unit credit Math 101C for individualized, interactive support in Trigonometry. For more information on math supports please visit: <https://www.laspositascollege.edu/math/mathjam.php>

A TI-84 or TI-83 calculator or internet-based software may be required for some sections of this course. Materials may be borrowed from the LPC Library or purchased in the bookstore.

MATH 40 STATISTICS AND PROBABILITY 4.0 Units

Descriptive statistics, including measures of central tendency, dispersion and position; elements of probability; confidence intervals; hypothesis tests; two-population comparisons; correlation and regression; goodness of fit; analysis of variance; applications in various fields. Introduction to the use of a computer software package to complete both descriptive and inferential statistics problems.

Prerequisite: Intermediate Algebra or a higher level of level of mathematics.

A TI-84 or TI-83 calculator or internet-based software may be required for some sections of this course. Materials may be borrowed from the LPC Library or purchased in the bookstore.

MATH 47 MATHEMATICS FOR LIBERAL ARTS 3.0 Units

An introduction to a variety of mathematical concepts for students interested in liberal arts. Intended to cultivate an appreciation of the significance of mathematics in daily life and help develop students' mathematical reasoning. Topics include personal finance, probability and statistics, logic, exponential growth, and graph theory.

Prerequisite: Intermediate Algebra or a higher level of mathematics.

Students are strongly encouraged to enroll in a tuition-free noncredit NMAT 200C or a 1-unit credit Math 100C for individualized, interactive support in Math for Liberal Arts. For more information on math supports please visit: <https://www.laspositascollege.edu/math/mathjam.php>

A TI-84 or TI-83 calculator or internet-based software may be required for some sections of this course. Materials may be borrowed from the LPC Library or purchased in the bookstore.

**MATH
- MATH JAM -**

Math Jam is a 1-week support course prior to the start of the semester for students who wish to prepare for their upcoming Calculus course prior to the start of the semester. This course is designed to prepare students to register for the calculus sequence with confidence, having learned key

math concepts and learning skills necessary to succeed in college courses.

Jams for Math 30, 39, 34, 40, 47, and 33 preparation are also offered as non-credit classes. Please see that section for more information.

MATH 66 MATH JAM FOR CALCULUS 0.5 Units

Math Jam for Calculus I is a credit course for students preparing for Calculus I. Embedded are essential study and life skills to develop each student holistically, including career development. Students will be learning basic skills and transfer-level material with the goal of preparing them to be successful in their upcoming class.

It is strongly recommended that students taking this course are enrolled in a calculus course.

This course is designed to prepare students to register for the calculus sequence with confidence, having learned key math concepts and learning skills necessary to succeed in college courses. For more information on math supports please visit: <https://www.laspositascollege.edu/math/mathjam.php>

MATH 67 MATH JAM FOR CALCULUS II 0.5 Units

Math Jam for Calculus II is a credit course for students preparing for Calculus II. Embedded are essential study and life skills to develop each student holistically, including career development. Students will be learning basic skills and transfer-level material with the goal of preparing them to be successful in their upcoming class.

It is strongly recommended that students taking this course are enrolled in a calculus course.

This course is designed to prepare students to register for the calculus sequence with confidence, having learned key math concepts and learning skills necessary to succeed in college courses. For more information on math supports please visit: <https://www.laspositascollege.edu/math/mathjam.php>

MATH 68 MATH JAM FOR CALCULUS III 0.5 Units

Math Jam for Calculus III is a credit course for students preparing for Calculus III. Embedded are essential study and life skills to develop each student holistically, including career development. Students will be learning basic skills and transfer-level material in their upcoming class.

It is strongly recommended that students taking this course are enrolled in a calculus course.

Math Jam for Calculus III is a 1-week support course prior to the start of the semester for students who wish to prepare for their upcoming Calculus I course prior to the start of the semester. This course is designed to prepare students to register for the calculus sequence with confidence, having learned key math concepts and learning skills necessary to succeed in college courses. For more information on math supports please visit: <https://www.laspositascollege.edu/math/mathjam.php>

**MATH
- CONCURRENT SUPPORT -**

These STRONGLY RECOMMENDED 1-unit lab courses are aligned with your math course and designed with innovative strategies to provide math and learning support while taking a math course. Whether your math class is foundational or transfer level, the concurrent support provides assistance in understanding the content in your current math course while learning essential study skills necessary to succeed in college courses.

These classes are offered for credit or tuition-free (noncredit), with the exception of MATH 66C, 67C, and 68C.

MATH 66C SUPPORT FOR CALCULUS I 1.0 Units

This course offers structured support to students who are concurrently enrolled in Calculus I. The support course includes material to prepare students for the rigor of the calculus course by teaching learning skills necessary to succeed in college courses as well as review of relevant prerequisite algebraic, geometric and trigonometric concepts, and more in-depth investigation of core concepts in their concurrent math course.

Corequisite: MATH 1

This is a recommended support course for students currently enrolled in Math I. There are no materials fee for this course. For more information please visit: <http://www.laspositascollege.edu/math/concurrentfaq.php>

MATH 67C CONCURRENT SUPPORT CALCULUS II 1.0 Units

This course offers structured support to students who are concurrently enrolled in Calculus II. The support course includes material to prepare students for the rigor of the calculus course by teaching learning skills necessary to succeed in college courses as well as review of relevant prerequisite algebraic, geometric and trigonometric concepts, and more concurrent math course.

Corequisite: MATH 2

This is a recommended support course for students currently enrolled in Math 2. Aligned with your math course and designed with innovative strategies to provide math and learning support while you are taking your math course. There are no materials fee for this course. For more information please visit: <http://www.laspositascollege.edu/math/concurrentfaq.php>

MATH 68C CONCURRENT SUPPORT CALCULUS III 1.0 Units

This course offers structured support to students who are concurrently enrolled in Calculus III. The support course includes material to prepare students for the rigor of the calculus course by teaching learning skills necessary to succeed in college courses as well as review of relevant prerequisite algebraic, geometric and trigonometric concepts, and more in-depth investigation of core concepts in their concurrent math course.

Corequisite: MATH 3

This is a recommended support course for students currently enrolled in Math III. Aligned with your math course and designed with innovative strategies to provide math and learning support while you are taking your math course. There are no materials fee for this course. For more information please visit: <http://www.laspositascollege.edu/math/concurrentfaq.php>

MATH 100C CONCURRENT SUPPORT SLAM MATH 1.0 Units

Concurrent Support for SLAM Math is for students interested in disciplines that require Statistics and Liberal Arts Mathematics (SLAM) courses. This course offers structured support to students who are concurrently enrolled in a first-level transfer course, such as Statistics and Mathematics for Liberal Arts, and Finite Mathematics. The support course includes material to prepare students for the rigor of the transfer math course by teaching learning skills necessary to succeed in college courses as well as review of relevant prerequisite algebraic and geometric concepts, and more in-depth investigation of core concepts in their concurrent math course.

Corequisite: MATH 40 or MATH 47 or MATH 33

This is a STRONGLY RECOMMENDED support course for students currently enrolled in Math 27, Math 33, Math 40 or Math 47. It is designed to prepare students for the rigor of the SLAM (Statistics and Liberal Arts Mathematics) transfer-level courses and develop the learning skills necessary to succeed in college courses. Aligned with your math course and designed with innovative strategies to provide math and learning support while you are taking your math course. This class is offered for credit (MATH 100C) or for tuition-free noncredit (NMAT 200C). There are no materials fee for this course. For more information please visit: <https://www.laspositascollege.edu/math/mathjam.php>

MATH 101C CONCURRENT SUPPORT BSTEM MATH 1.0 Units

Concurrent Support for BSTEM Mathematics is for students interested in Business, Science, Technology, Engineering and Mathematical

fields. This course offers structured support to students who are concurrently enrolled in a first-level transfer course, such as College Algebra, Trigonometry, and Business Calculus. The support course includes material to prepare students for the rigor of the transfer math course by teaching learning skills necessary to succeed in college courses as well as review of relevant prerequisite algebraic and geometric concepts, and more in-depth investigation of core concepts in their concurrent math course.

Corequisite: MATH 30 - This is a one-way corequisite for Math 30. Everyone taking this NMAT 201C concurrent support course must be taking a Math 30, Math 39 or Math 34 class concurrently. However, not everyone taking Math 30 would have to take this NMAT 201C concurrent support course.

Or MATH 39 - This is a one-way corequisite for Math 39. Everyone taking this NMAT 201C concurrent support course must be taking a Math 30, Math 39 or Math 34 class concurrently. However, not everyone taking Math 39 would have to take this NMAT 201C concurrent support course.

Or MATH 34 - This is a one-way corequisite for Math 34. Everyone taking this NMAT 201C concurrent support course must be taking a Math 30, Math 39 or Math 34 class concurrently. However, not everyone taking Math 34 would have to take this NMAT 201C concurrent support course.

This is a STRONGLY RECOMMENDED support course for students currently enrolled in Math 30, Math 34 or Math 39. This 1-unit lab is designed to prepare students for the rigor of the BSTEM (Business, Science, Technology, Engineering and Mathematics) transfer-level courses and develop the learning skills necessary to succeed in college courses. Aligned with your math course and designed with innovative strategies to provide math and learning support while you are taking your math course. This class is offered for credit (MATH 101C) or for tuition-free noncredit (NMAT 201C). There are no materials fee for this course. For more information please visit: <https://www.laspositascollege.edu/math/mathjam.php>

MUSIC

MUS 1 INTRODUCTION TO MUSIC 3.0 Units

Music for enjoyment and understanding through informed listening, analysis, evaluation and discernment of musical elements, forms, and repertoire. Attendance at concerts and listening to a variety of music may be required.

MUS 3 WORLD MUSIC 3.0 Units

The study of the folk and art music of world cultures. Includes the traditional music of Sub-Saharan Africa, Middle East, China, Japan, Indonesia, India, Latin America, Europe, and Native America. Attendance at world music concerts is required.

MUS 4 JAZZ IN AMERICAN CULTURE 3.0 Units

History, trends, and influences of the phenomenon of jazz through integration of the cultures of (but not limited to) African-American, European-American and the Latin-American communities. Required listening, reading and concert attendance will guide the student to value jazz as a form of self-expression and improve the ability to listen and understand the various eras in jazz from pre-Dixieland to present day.

MUS 5 AMERICAN CULTURES IN MUSIC 3.0 Units

Music in twentieth century United States through the study of contributions of three selected groups from the following: African-Americans, Latin-Americans, Asian-Americans, European-Americans, and Native Americans. Emphasis on understanding diverse styles, and on integrating these styles into American music. Concert, religious, and folk-pop music will be included.

Scan here to visit the current Spring 2024 class schedule online



MUS 6 BASIC MUSIC SKILLS 2.0 Units
Essentials of music through notation, time elements, melody, harmony, and tonality, texture, dynamics and knowledge of the keyboard. Sight singing and ear training.

MUS 8B THEORY AND MUSICIANSHIP 2 4.0 Units
Continues diatonic harmony through part writing and ear training exercises as typified by musical practice from 1600 to the present, continues solfeggio, chord recognition, melodic and rhythmic dictation, voice leading involving four -part choral writing, and figured bass realization. Introduces harmonic dictation, cadential elaboration, non-dominant seventh chords, and an introduction to secondary/applied chords and modulation.

Prerequisite: MUS 8A with a minimum grade of C

Strongly Recommended: MUS 8A, MUS 21A with a minimum grade of C

MUS 10B THEORY AND MUSICIANSHIP 4 4.0 Units
This course incorporates the concepts from Music 10A. In addition, through writing and analysis, the course will include: post-Romantic techniques such as borrowed chords and modal mixture, chromatic mediants, Neapolitan and augmented-sixth chords, 9th, 11th and 13th chords, altered chords and dominants; and 20th century techniques such as: Impressionism, tone rows, set theory, pandiatonicism and polytonalism, meter and rhythm. This course also applies and develops the rhythmic, melodic, and harmonic materials of MUS 10A through ear training, sight singing, analysis, and dictation.

Prerequisite: MUS 10A with a minimum grade of C

MUS 11 COMMERCIAL MUSIC COMBO 1.0 Units
For instrumentalists and vocalists who want experience in performing and interpreting small-group commercial music literature. Emphasis will be on articulations, stylistic differences, composition, arranging, and common performance practices.

Recommended Course Preparation: MUS 18A and MUS 6 with a minimum grade of C

Enrollment by audition only.

MUS 13 HISTORY OF ROCK AND ROLL 3.0 Units
A cultural survey of original American music traditions, forms and trends influenced by cultural, socio-economic, socio-political and economic changes including blues, jazz, early rock, the British Invasion, rap, hip hop culture, Latino rock, heavy metal, jazz-rock fusion, electronic, modern rock, and pop.

MUS 15 JAZZ ENSEMBLE 1.0 Units
This course is for the study, rehearsal, and public performance of standard jazz ensemble literature, with an emphasis on the development of skills needed to perform within an ensemble. New literature will be studied each term so that different technical and artistic issues are addressed. Opportunities to arrange and compose for the ensemble as well as to conduct. Opportunity to apply improvisation techniques in a group setting.

Enrollment by audition only.

MUS 16 PHILHARMONIC ORCHESTRA 1.0 Units
This course is for the study, rehearsal, and public performance of the standard Classical orchestra literature, with an emphasis on the development of skills needed to perform within an ensemble. Different literature is studied each semester so that different technical, historical and artistic issues are addressed. Attendance at all scheduled performances is required. Audition required.

Enrollment by audition only.

MUS 17A JAZZ COMBO 1 1.0 Units
For instrumentalists who want experience in performing and

interpreting small-group literature. The music literature will cover important aspects of Jazz band development and works of all styles and periods. Emphasis will be on articulations, stylistic differences, composition, arranging, and common performance practices of the various periods of music.

Recommended Course Preparation: MUS 18A, MUS 6 with a minimum grade of C

Enrollment by audition only.

MUS 18A JAZZ/POP PIANO 1 1.0 Units
Voicings, chords, and guidelines for interpretation of lead sheets in a variety of genres for the contemporary pianist. Emphasis on improvisation, accompaniment, bass lines, grooves, and reharmonization.

Recommended Course Preparation: MUS 21A with a minimum grade of C.

MUS 18B JAZZ/POP PIANO 2 1.0 Units
Building on the content offered in Music 18A, this course offers more advanced voicings, chords, and guidelines for interpretation of lead sheets in a variety of genres for the contemporary pianist. The student learns chords and chord progressions used in jazz and popular music styles as applied to the keyboard, focusing on chromatic seventh chords and sequences, chord extensions and advanced rhythmic concepts.

Prerequisite: MUS 18A with a minimum grade of C

MUS 19 STUDIES IN MUSIC COMPOSITION 3.0 Units
Presents a technical and historical analysis of works in various music languages. Students will compose individual pieces to be performed by college-based music ensembles.

Recommended Course Preparation: MUS 8A with a minimum grade of B

MUS 21A BEGINNING PIANO 1.0 Units
Group instruction in piano for the absolute beginner with emphasis on developing technique, reading music, and performing.

Recommended Course Preparation: MUS 6

MUS 21B INTERMEDIATE PIANO 1.0 Units
Development of skills learned in Music 21A. Emphasis on further development of technique and performance.

Prerequisite: Mus 21A with a minimum grade of C

MUS 23A ELEMENTARY VOICE 1.0 Units
Group singing with an emphasis on healthy vocal production, solo performance opportunities, breathing, diction, sight singing, and the study of vocal anatomy.

Recommended Course Preparation: MUS 6 - Basic Music Skills

MUS 23B INTERMEDIATE VOICE 1.0 Units
Further development of skills learned in Music 23A. Emphasis on continued development of vocal production, solo performance practice, sight singing, the International Phonetic Alphabet, and interpretation of non- English literature.

Prerequisite: MUS 23A with a minimum grade of C

Recommended Course Preparation: MUS 8A with a minimum grade of C

MUS 28 KEYBOARD SKILLS 1.0 Units
Emphasis on correct harmonization of melodies with various styles of piano accompaniments; transposition; improvisation ; modulation; sight reading; principles of accompanying soloists and groups; ensemble playing; playing by ear. Frequent solo and ensemble performances in class. Intended for piano teachers or classroom music teachers.

Recommended Course Preparation: MUS 21B

MUS 31 STUDY OF PIANO 1.0 Units
 Building off of knowledge and skills from MUS 21B, MUS 31 continues development of functional piano skill for intermediate or advanced level.
Prerequisite: MUS 21B with a minimum grade of C

MUS 34 MUSIC IN FILM 3.0 Units
 The class traces the history and development of film music through reading, lecture and film viewing. The class studies the process of film scoring and how music and its relationship to film have changed over the last century. Class includes discussion and evaluation of different compositional styles and learning to listen critically to film scores while viewing movies.

MUS 36 INTERMEDIATE MUSIC TECHNOLOGY 3.0 Units
 This course is the 2nd level course in the music technology series. Topics include intermediate/advanced computer skills, software-based sequencing, synthesis, MIDI, sampling, notation, principles of sound, microphones, introduction to digital audio, signal processing, mixers and mixing, recording principles, cables and interconnects, and audio in live performance.
Prerequisite: MUS 35

MUS 38 APPLIED LESSONS 1.0 Units
 Individualized study of the appropriate techniques and repertoire for the specific instrument or voice being studied. The emphasis is on the progressive development of skills needed for solo performance. Achievement is evaluated through a juried performance. Enrollment subject to a standardized audition demonstrating basic competencies in technique and musicianship in their major performance medium.
Corequisites: MUS 8A or MUS 8B or MUS 10A or MUS 10B or MUS 12 or MUS 14 or MUS 15 or MUS 16 or MUS 44 or MUS 45 or MUS 46A or MUS 46B or MUS 48.

Special Approval Needed: To enroll in Applied Lessons MUS 38, students are required to concurrently enroll in Music Theory (MUS 8A, 8B, 10A, or 10B) and a Performing Ensemble. Contact Dan Marschak dmarschak@laspositascollege.edu for more information and an Add Code.

- | | | |
|---------------|-------------------------------------|------------------|
| MUS 38 | APPLIED LESSONS- BASS | 1.0 Units |
| MUS 38 | APPLIED LESSONS- BASSOON | 1.0 Units |
| MUS 38 | APPLIED LESSONS- CELLO | 1.0 Units |
| MUS 38 | APPLIED LESSONS- COMPOSITION | 1.0 Units |
| MUS 38 | APPLIED LESSONS- DRUMS | 1.0 Units |
| MUS 38 | APPLIED LESSONS- FLUTE | 1.0 Units |
| MUS 38 | APPLIED LESSONS- GUITAR | 1.0 Units |
| MUS 38 | APPLIED LESSONS- JAZZ VOICE | 1.0 Units |
| MUS 38 | APPLIED LESSONS- JAZZ PIANO | 1.0 Units |
| MUS 38 | APPLIED LESSONS- LOW BRASS | 1.0 Units |
| MUS 38 | APPLIED LESSONS- PERCUSSION | 1.0 Units |
| MUS 38 | APPLIED LESSONS- PIANO | 1.0 Units |
| MUS 38 | APPLIED LESSONS- TRUMPET | 1.0 Units |
| MUS 38 | APPLIED LESSONS- VOICE | 1.0 Units |
| MUS 38 | APPLIED LESSONS- WOODWINDS | 1.0 Units |

MUS 41 INSTRUMENTAL CHAMBER MUSIC 1.0 Units
 This course is an instrumental music ensemble that performs selections from the standard classical repertoire, as well as modern compositions. Students develop all aspects of instrumental performance including technique, sight-reading, intonation, rhythmic interpretation, ensemble balance, and stylistic interpretation. Musical instruments may include members of the brass, woodwind, string, percussion, and keyboard families.
Enrollment by audition only.

MUS 45 CHAMBER CHOIR 2.0 Units
 A performance-based class furthering the effective study, interpretation, and presentation of choral literature. Designed for vocalists with previous classical ensemble experience. Performs multiple times per semester.
Recommended Course Preparation: MUS 6, MUS 44 with a minimum grade of C
Enrollment by audition only.

MUS 46 VOCAL JAZZ ENSEMBLE 2.0 Units
 An advanced performance-based class exploring jazz voice in an ensemble setting. Course emphasizes the study of a variety of jazz and pop/rock styles, overall healthy vocal technique, use of microphones and an active sound system, vocal improvisation, and overall musicianship. Singing and ensemble experience highly recommended, as the class requires strong sense of intonation, rhythm, and vocal blend. Performs multiple times per semester.
Recommended Course Preparation: MUS 6, MUS 44 with a minimum grade of C
Enrollment by audition only.

MUS 48 IMPROVISATION LAB 1.0 Units
 This course exposes students to the fundamental concepts and skills needed for improvising in a group setting. The course is open to instrumentalists or vocalists at any level of proficiency, with no audition or prior improvisation experience required. The course is intended to expose students to the role of improvisation in a variety of music genres, and to provide experience playing in different-sized ensembles. The course prepares students for established advanced jazz ensembles in the department like Jazz Combos, Jazz Ensemble, and Vocal East. Emphasis will be on group activities, individual projects, independent listening and practice, basic theory concepts, and performance.
Recommended Course Preparation: MUS 6 or MUS 8A with minimum grade of C
Enrollment Limitation: Audition Required - Performing ensembles require auditions per C-ID.

NONCREDIT AUTOMOTIVE TECH

NAUT A4 SUSPENSION AND STEERING 0.0 Units
 Diagnosis, evaluation, testing, adjustment, alignment and repair of steering and suspension systems. Including all common automotive steering and suspension systems both car and truck. Future systems will also be covered.
Prerequisite: AUTO INTR or NAUT INTR or AUTO INTL and AUTO INTZ
Students are strongly recommended to enroll in Automotive Lab concurrently.



Scan here to visit the current Spring 2024 class schedule online

NAUT A5 BRAKES 0.0 Units

Diagnosis, evaluation, inspection, adjustment, and repair of braking, antilock braking systems, traction control and related devices. Class will involve California State law regarding brake and safety inspections. Includes the material on the California Brake Adjuster's Licensing Examination.

Prerequisite: AUTO INTR or NAUT INTR or AUTO INTL and AUTO INTZ with a minimum grade of C May be taken concurrently

Students are strongly recommended to enroll in Automotive Lab concurrently.

NAUT A6 ELECTRICAL/ELECTRONIC SYSTEMS 0.0 Units

Automotive electrical/electronic systems, including electrical circuits, Ohm's Law, battery, starting, charging, ignition, fuel, accessories, brakes, chassis, suspension, steering, HVAC, and wiring systems. Emphasis on diagnosis of electrical troubles, assembly, repair of components, and diagnostic equipment usage.

Prerequisite: NAUT INTR or AUTO INTR or AUTO INTL or AUTO INTZ with a minimum grade of C. May be taken concurrently

Students are strongly recommended to enroll in Automotive Lab concurrently.

NAUT CINTR CONCEPTS OF AUTOMOTIVE SERVICE 0.0 Units

This class is lecture only and non-credit. Bumper-to-Bumper Automotive Knowledge. Starting with hazardous waste handling, tool identification, maintenance and lubrication, moving into engine mechanical, emissions controls, suspension systems, air conditioning, airbags and safety, transmissions, axles, and finishing off with the future of the automotive industry. This is an introductory class for people who want to know more about their vehicle.

NAUT INTR AUTO SERVICE AND INTRODUCTION 0.0 Units

Bumper-to-Bumper Automotive Knowledge. Starting with hazardous waste handling, tool identification, maintenance and lubrication, moving into engine mechanical, emissions controls, suspension systems, air conditioning, airbags and safety, transmissions, axles, and finishing off with the future of the automotive industry. This is an introductory class for people who want to know more about their vehicle or who are planning an automotive career.

NAUT L1L2 SMOG LEVEL ONE AND LEVEL TWO 0.0 Units

This course includes classes/modules the State of California's requires for a student/automotive technician to be prepared to take their Smog License Test. This class will include Level One and Level Two smog training only. At the end of the class students may or may not qualify for either EI or EO smog license. See www.smogcheck.ca.gov for more information.

NAUT LABA AUTOMOTIVE LAB 0.0 Units

Automotive Lab is an open laboratory class for basic automotive students. This class is for students desiring to expand their hands-on experience using their own vehicle. Instructor will provide technical and supervisory support to guide students in completion of their self initiated projects. Service information via computer service manuals will be available for students to use for vehicle information and research.

Prerequisite: AUTO INTR or NAUT INTR or AUTO INTL and AUTO INTZ with a minimum grade of C. May be taken concurrently.

NAUT LABB AUTOMOTIVE LAB ADVANCED 0.0 Units

Automotive Lab Advanced is an open laboratory class for advanced automotive students. This class is for students desiring to expand their hands-on experience using their own vehicle. Instructor will provide technical and supervisory support to guide students in completion of their self initiated projects. Students are expected to help others in class and be able to work without guidance. Service information via computer service manuals will be available

for students to use for vehicle information and research. Class is recommended for second year students only.

Prerequisite: AUTO LABA or NAUT LABA and AUTO INTR or NAUT INTR or AUTO INTL and AUTO INTZ with a minimum grade of C (May be taken concurrently).

NAUT LABC LAB SPECIALIZED BENCH WK 0.0 Units

Automotive Lab Advanced is an open laboratory class for automotive students. This class is for students desiring to expand their hands-on experience using shop equipment. This class specializes in rebuilding automotive parts. The instructor will provide technical and supervisory support to guide students in the completion of their self-initiated projects. Service information via computer service manuals will be available for students to use for vehicle information and research. Class is recommended for second year students only.

Prerequisite: AUTO INTR or NAUT INTR or AUTO INTL and AUTO INTZ with a minimum grade of C. May be taken concurrently.

NAUT LABD LAB SPECIALIZED ELECTRONIC WK 0.0 Units

Automotive Lab Specialized Electronic Work is an open laboratory class for automotive students. This class is for students desiring to expand their hands-on experience using shop equipment. This class specializes in electronics work. This includes accessories, EV, hybrid, and aftermarket electrical. The instructor will provide technical and supervisory support to guide students in the completion of their self-initiated projects. Service information via computer service manuals will be available for students to use for vehicle information and research

Prerequisite: AUTO INTR or NAUT INTR or AUTO INTL and AUTO INTZ with a minimum grade of C. May be taken concurrently.

NONCREDIT AVIATION

NAVI 201 DRONES AND AERIAL SYSTEMS(UAS) 0.0 Units

This course introduces students to the fundamentals of drones and Unoccupied Aerial System (UAS) focused on mission planning, basic flight operations and the legal (local, state, and federal) and ethical frameworks in order to safely operate a UAS. Course includes a hands-on lab component.

NAVI 202 DRONE AERIAL, PHOTO AND VIDEO 0.0 Units

This course is an introduction to using drones and Unoccupied Aerial Systems (UAS) to capture and process a wide array of remote sensing data and digital imagery. It will cover pre-flight planning, in-flight choreography, and post processing stages. An emphasis is developing post-processing skills for commercial applications with exposure to the craft of report writing, cartography, and desktop stills/video editing. This is a creative starting point to using drones in multiple disciplines and careers. Course includes a hands-on laboratory component.

Recommended Course Preparation: NAVI 201 with a minimum grade of C, or GEOG 15 with a minimum grade of C, or PHTO 56 with a minimum grade of C, or PHTO 58 with a minimum grade of C.

NAVI 203 FAA REMOTE PILOT CERT. PREP 0.0 Units

This course prepares students to pass the FAA Part 107 Remote Pilot Certificate exam. It will focus on the main sections of the exam including: the basic flight operations, the legal and ethical frameworks, safety considerations, airspace classification, operating requirements, flight restrictions and the effects of weather on a drone's performance.

NONCREDIT BUSINESS

NBUS 200 COMMUNICATION IN THE WORKPLACE 0.0 Units

This course introduces the key elements for communication in the professional workplace, and is beneficial for students seeking to improve their interpersonal communication skills.

NBUS 212 DEVELOPING YOUR BUSINESS PLAN 0.0 Units

This is a course designed for students considering starting their own businesses. All major elements of a business plan will be covered, including financial statements, marketing, and competitive strategies.

NBUS 213 LEGAL ASPECTS SMALL BUSINESS 0.0 Units

This course is designed for students interested in establishing a business and who need information about the legal issues involved. Legal aspects such as forms of ownership, licensing, and taxes will be covered.

Students are strongly encouraged to enroll in a tuition-free, noncredit NMAT 200C or a 1-unit credit Math 100C for individualized, interactive support in Statistics.

A TI-84 or TI-83 calculator or internet-based software may be required for some sections of this course. There may be a fee associated with these materials. Consult with the instructor or bookstore before registering for this course.

NBUS 214 SUCCESS IN THE GIG ECONOMY 0.0 Units

This course provides students with a hands-on class experience in starting a side business that can add to a student's income stream or grow into a full-time business. Students will learn to: identify income producing opportunities, develop business and promotion plans, and fund, launch, refine their business and make a profit. Emphasis will be placed on experiential learning, taking action and the iterative refinement process needed to start a new business.

NBUS 233 PERSONAL FINANCIAL MANAGEMENT 0.0 Units

Designed to provide students with the practical, hands-on means of successfully managing their personal finances and of becoming financially empowered upon course completion. Among other topics, the course will cover the basics of credit management, assessing insurance needs, budgeting, personal financial statement preparation, investment and savings accounts, management of taxes, retirement accounts, will preparation and estate planning.

NONCREDIT ESL

NESL 203 LANGUAGE FOR YOUR CHILD'S LEARNING 0.0 Units

School Matters 1 will teach English Learners the listening and speaking, reading and writing, and vocabulary skills necessary to help support their child's learning in the K-12 school system. This class focuses specifically on supporting your child in their classroom (for example, language skills for contacting your child's teacher), and supporting your child's learning at home (for example, reading and writing skills for helping your child with homework).

Recommended Course Preparation: NESL 231A and/or Completion of ESL Level 1A, or placement into ESL Level 1B through the ESL Assessment.

NESL 204 LANGUAGE FOR CHILD'S COMMUNITY 0.0 Units

School Matters 2 will teach English Learners the listening and speaking, reading and writing, and vocabulary skills necessary to engage with their child's K-12 school community. This class focuses specifically on language skills for interacting with school administration (for example, speaking skills for engaging office staff

about a child's absence), and interacting with the greater school community (for example, speaking skills for volunteering at your child's school).

NESL 213 SPEAKING AND LISTENING FLUENCY 0.0 Units

This is an oral communication course that will enable students to develop advanced speaking and listening fluency for academic and professional purposes. ESL 113 will enable students to fluently use linguistic forms accurately, meaningfully and appropriately, emphasizing academic and professional discourse. Students will practice listening and responding to academic lectures and presentations like TED Talks, including note-taking, summarizing, and other forms of critical analysis. Speaking practice will emphasize advanced rhetorical strategies through group discussions, debates, impromptu speeches and oral presentations and cultural norms in academic and professional contexts. It is the fifth and highest level of the ESL Speaking and Listening Fluency Pathway.

Prerequisite: NESL 223 or ESL 123 or NESL 226 or ESL 226 with a minimum grade of Pass or Placement into Advanced ESL courses through the ESL Assessment Process.

NESL 220A INTERMEDIATE GRAMMAR READING 0.0 Units

This is the first semester of a one-year course in intermediate grammar for academic writing and reading designed to enable students to identify, comprehend, and use linguistic forms accurately, meaningfully and appropriately in reading and writing. The course focuses on types of sentences, clauses, and phrases, word order, verb forms, verb tenses, and on the connection between vocabulary and grammar.

Prerequisite: NESL 230B or ESL 130B with a minimum grade of P or placement through the ESL assessment process

Students are advised to enroll concurrently in NESL 220A and NESL 221A, and ESL 123 or ESL 126.

NESL 220B HIGH-INTERMEDIATE GRAMMAR 0.0 Units

This is the second semester of a one-year course in intermediate grammar for academic writing and reading designed to enable students to use linguistic forms accurately, meaningfully and appropriately in written expression. The course focuses on types of sentences, clauses, phrases, word order, verb forms, verb tenses, and on the connection between vocabulary and grammar. This course also emphasizes analyzing grammar and meaning and detecting and correcting grammatical errors.

Prerequisite: NESL 220A or ESL 120A with a minimum grade of P or placement through the ESL assessment process

Students are advised to enroll concurrently in NESL 220B and NESL 221B, and ESL 123 or ESL 126.

NESL 221A INTERMED. READING AND WRITING 0.0 Units

This is the first semester of a one-year course in intermediate academic writing and reading. Classes will focus on writing sentences, paragraphs and compositions, developing strategies for reading comprehension and flexibility, on interactive reading, and on academic vocabulary development. Students will develop cultural understanding, vocabulary, and fluency through a variety of academic writing and reading tasks.

Prerequisite: NESL 231B or ESL 131B with a minimum grade of P or placement through ESL assessment process

Students are advised to enroll concurrently in NESL 220A and NESL 221A, and ESL 123 or ESL 126.

Scan here to visit the current Spring 2024 class schedule online



NESL 221B INTERMEDIATE READING & WRITING 0.0 Units

This is the second semester of a one-year course in intermediate academic writing and reading. Classes will focus on writing sentences, paragraphs and compositions, developing strategies for reading comprehension and flexibility, on interactive reading, and academic vocabulary development. Students will develop cultural understanding and fluency through a variety of academic writing and reading tasks.

Prerequisite: NESL 221A or ESL 121A with a minimum grade of Pass or Placement through ESL assessment process.

Students are advised to enroll concurrently in NESL 221B and NESL 220B, and ESL 123 or ESL 126.

NESL 226 INTERMED. PRONUNCIATION & FLUENCY 0.0 Units

Focused practice on recognizing and producing intonation patterns, and grammatical signals through activities such as oral presentations, role play, authentic dialogue, and reading presentations.

Prerequisite: ESL 130B or ESL 131B or ESL 136 with a minimum grade of P or placement through ESL assessment process

NESL 230A BEG. GRAMMAR READING & WRITING 0.0 Units

This is the first semester of a one-year course in beginning grammar for academic purposes designed to enable students to understand and use English accurately, meaningfully and appropriately. The course focuses on the connection between vocabulary and grammar, simple and compound sentences, phrases, verb forms, and verb tenses, especially simple and compound sentences, phrases, verb forms, and verb tenses, especially simple present, simple past, and present progressive.

Recommended Course Preparation: Placement through the ESL assessment process

Students are advised to enroll concurrently in NESL 230A and NESL 231A, and ESL 133 or ESL 136.

NESL 230B HIGH-BEGINNING GRAMMAR 0.0 Units

This is the second semester of a one-year course in beginning grammar for academic purposes designed to enable students to identify and use linguistic forms accurately, meaningfully and appropriately in written expression. The course focuses on simple and compound sentences, word order, verb tenses: simple present, past, and future as well as present and past progressive, verb forms, modals, phrases, and vocabulary development.

Prerequisite: NESL 230A or ESL 130A with a minimum grade of P or placement through the ESL assessment process

Students are advised to enroll concurrently in NESL 230B, NESL 231B, and ESL 133 or ESL 136.

NESL 231A BEGINNING READING AND WRITING 0.0 Units

This is the first semester of a one-year course in beginning academic writing and reading. Classes will focus on writing simple and compound sentences in short paragraphs, on developing strategies for increasing reading comprehension and flexibility, on interactive reading, and on developing academic vocabulary. Students will develop cultural understanding and fluency through a variety of writing and reading tasks.

Recommended Course Preparation: Appropriate skill level demonstrated through the ESL assessment process

Students are advised to enroll concurrently in NESL 231A and NESL 230A, and ESL 133 or ESL 136.

NESL 231B HIGH- BEG. READING AND WRITING 0.0 Units

This is the second semester of a one-year course in beginning academic writing and reading. Classes will focus on writing simple, compound, and complex sentences in structured paragraphs, on developing strategies for increasing reading comprehension and on developing academic vocabulary. Students will develop cultural understanding and fluency through a variety of writing and reading

tasks.

Prerequisite: NESL 231A or ESL 131A with a minimum grade of Pass or Placement through ESL assessment process

Students are advised to enroll concurrently in NESL 231B and NESL 230B, and ESL 133 or ESL 136.

NESL 236 BEGINING PRONUNCIATION & FLUENCY 0.0 Units

Focused practice on recognizing and producing individual speech sounds, stress patterns, rhythm and intonation patterns, and grammatical signals through activities such as oral presentations, role play, authentic dialogue, and presentations. Students will focus on developing listener friendly pronunciation. Course content includes individual as well as group work.

Recommended Course Preparation: Placement through the ESL Assessment process.

NONCREDIT KINESIOLOGY

NKIN FCOA FITNESS CENTER-OLDER ADULTS 0.0 Units

Individualized exercise program will be created for older adults based on training principles and personal goals. The following considerations for older adult populations will be incorporated: Maintaining bone density, improving balance, coordination, and mobility, as well as appropriate strength training exercises. Also, a health risk appraisal will be conducted.

NONCREDIT MATH - CONCURRENT SUPPORT-

NMAT 200C CONCURRENT SUPPORT SLAM MATH 0.0 Units

Concurrent Support for SLAM Math is for students interested in disciplines that require Statistics and Liberal Arts Mathematics (SLAM) courses. This course offers structured support to students who are concurrently enrolled in a first-level transfer course, such as Statistics and Mathematics for Liberal Arts, and Finite Mathematics. The support course includes material to prepare students for the rigor of the transfer math course by teaching learning skills necessary to succeed in college courses as well as review of relevant prerequisite algebraic and geometric concepts, and more in-depth investigation of core concepts in their concurrent math course.

Corequisite: MATH 40 or MATH 47 or MATH 33

This is a STRONGLY RECOMMENDED support course for students currently enrolled in Math 27, Math 33, Math 40 or Math 47. It is designed to prepare students for the rigor of the SLAM (Statistics and Liberal Arts Mathematics) transfer-level courses and develop the learning skills necessary to succeed in college courses. Aligned with your math course and designed with innovative strategies to provide math and learning support while you are taking your math course. This class is offered for credit (MATH 100C) or for tuition-free noncredit (NMAT 200C). There are no materials fee for this course. For more information please visit: <https://www.laspositascollege.edu/math/mathjam.php>

NMAT 201C CONCURRENT SUPPORT BSTEM MATH 0.0 Units

Concurrent Support for BSTEM Math is for students interested in Business, Science, Technology, Engineering and Mathematical fields. This course offers structured support to students who are concurrently enrolled in a first-level transfer course, such as College Algebra, Trigonometry, and Business Calculus. The support course includes material to prepare students for the rigor of the transfer math course by teaching learning skills necessary to succeed in college courses as well as review of relevant prerequisite algebraic and geometric concepts, and more in-depth investigation of core concepts in their concurrent math course.

Corequisite: MATH 30 or MATH 39 or MATH 34 This is a one-way corequisite. Everyone taking this NMAT 201C concurrent support course

must be taking a Math 30, Math 39 or Math 34 class concurrently. However, not everyone taking Math 30 or Math 39 or Math 34 would have to take this NMAT 201C concurrent support course.

This is a **STRONGLY RECOMMENDED** support course for students currently enrolled in Math 30, Math 34 or Math 39. This 1-unit lab is designed to prepare students for the rigor of the BSTEM (Business, Science, Technology, Engineering and Mathematics) transfer-level courses and develop the learning skills necessary to succeed in college courses. Aligned with your math course and designed with innovative strategies to provide math and learning support while you are taking your math course. This class is offered for credit (MATH 101C) or for tuition-free noncredit (NMAT 201C). There are no materials fee for this course. For more information please visit: <https://www.laspositascollege.edu/math/mathjam.php>

NMAT 202C JUST IN TIME TUTORING FOR MATH 0.0 Units

This course offers individualized support tailored to college students seeking assistance with their mathematics coursework. Trained tutors and instructors will provide tutoring in foundational mathematics subjects. Students will also develop the study skills needed to succeed in their math classes.

NMAT 202C provides just-in-time math and learning support for students enrolled in a math course. Students can sign up for this class at any time during the semester and receive help from math instructors and/or peer-tutors. Help available throughout the week. Course times available in Canvas once you register. For more information on math supports please visit: <https://www.laspositascollege.edu/ilc>

NONCREDIT MATH - MATH JAM -

NMAT 264 MATH JAM FOR SLAM PREP 0.0 Units

Math Jam for SLAM Prep is for students preparing for math courses in Statistics and Probability or Mathematics for Liberal Arts. Math Jam is a FREE noncredit program designed to help students prepare for their upcoming math class at a community college. Embedded are essential study and life skills to develop each student holistically, including career development. Students will be learning prerequisite algebraic and basic probability material with the goal of preparing them to be successful in their upcoming first-level transfer course of Statistics or Math for Liberal Arts class.

It is strongly recommended that students taking this course be enrolled in Math 40: Statistics and Probability or Math 47: Mathematics for Liberal Arts at Las Positas College.

Math Jam for SLAM Prep is for students preparing for math courses in Statistics and Probability (MATH 40) or Mathematics for Liberal Arts (MATH 47). Math Jam is a 1-week, FREE noncredit program designed to help students prepare for their upcoming math class at a community college. Embedded are essential study and life skills to develop each student holistically, including career development. Students will be learning prerequisite algebraic and basic probability material with the goal of preparing them to be successful in their upcoming math class. For more information please visit: <https://www.laspositascollege.edu/math/mathjam.php>

NMAT 265 MATH JAM FOR BSTEM PREP 0.0 Units

Math Jam for BSTEM Prep is for students preparing for math courses in College Algebra, Trigonometry, Business Calculus and review prior to Calculus I. Math Jam is a noncredit program designed to help students prepare for their upcoming STEM focused math class at a community college. Embedded are essential study and life skills to develop each student holistically, including career development. Students will be learning pre-transfer level material with the goal of preparing them to be successful in their upcoming class. It is strongly recommended that students taking this course are enrolled in a community college math course.

Math Jam is a 1-week, FREE noncredit program designed to help students prepare for their upcoming STEM- focused math class at a community

college. Embedded are essential study and life skills to develop each student holistically, including career development. Students will be learning with the goal of preparing them to be successful in their upcoming math class. For more information please visit: <https://www.laspositascollege.edu/math/mathjam.php>

NONCREDIT MUSIC

NMUS 215 JAZZ BAND FOR OLDER ADULTS 0.0 Units

This course is for the study, rehearsal, and public performance of standard jazz ensemble literature for the older adult. Emphasis is on the development of skills needed to perform within an ensemble. New literature will be studied each term so that different technical and artistic issues are addressed. Opportunities to arrange and compose for the ensemble as well as to conduct. Opportunity to apply improvisation techniques in a group setting.

Enrollment Limitation: Audition required - Standardized audition demonstrating musical ability and technical proficiency at a level suitable to the course.

NMUS 216 ORCHESTRA FOR OLDER ADULTS 0.0 Units

This course is for the study, rehearsal, and public performance of the orchestral literature for the older adult, with a continued emphasis on the development of skills needed to perform within an ensemble. Different literature is studied each semester so that various technical, historical and artistic issues are addressed. Attendance at all scheduled performances is required. Audition required.

Enrollment Limitation: Audition required - Standardized audition demonstrating musical ability and technical proficiency at a level suitable to the course.

NUTRITION

NTRN 1 INTRO TO NUTRITION SCIENCE 3.0 Units

Scientific concepts of nutrition related to the function of nutrients, sources and recommended intakes. Nutritional assessment and the role of nutrition in the maintenance of health.

Recommended Course Preparation: Eligibility for college-level composition (ENG 1A, ENG 1AEX, or ESL 1A) as determined by college assessment or other appropriate method.

NTRN 5 SPORTS NUTRITION 3.0 Units

Students will study the role of nutrition in sports, performance and physical fitness. Optimal food, nutrient, and activity choices to maximize athletic performance for all athlete types.

Recommended Course Preparation: NTRN 1 with a minimum grade of C

OCCUPATIONAL SAFETY AND HEALTH

OSH 62 PHYSICAL HAZARDS 3.0 Units

Examination of physical hazards in the work environment and methods of control. Includes review of key hazards and regulatory requirements associated with human factors e.g., work area layout and planning, machine guarding, electrical safety, materials handling, rigging, conveyors, power tools, personal protective

Scan here to visit the current Spring 2024 class schedule online



equipment, compressed gases, illumination, and working surfaces. Emphasis on methods for observation and inspection of workplace conditions and practices.

PHILOSOPHY

PHIL 1 GOD, NATURE, HUMAN NATURE 3.0 Units

An exploration of the nature and range of philosophical inquiry in relation to everyday problems of humans as individuals, as citizens, as physical creatures, and as creators of spiritual and artistic works. Philosophical texts are analyzed with special attention given to the development of skills in analysis and argumentation. NOTE: Philosophy 2 and 4 are also introductory courses and may be taken before Philosophy 1 if a more detailed examination of ethical problems, the theory of knowledge, or political philosophy is desired.

Recommended Course Preparation: Eligibility for ENG 1A

STUDENTS MAY TAKE PHILOSOPHY COURSES IN ANY ORDER

PHIL 2 ETHICS 3.0 Units

This course covers the concepts of morality, values and influential ethical theories. Students taking this course will be required to use philosophical methods to evaluate these theories for themselves and show how these theories can apply to everyday ethical questions.

Recommended Course Preparation: Eligibility for ENG 1A

STUDENTS MAY TAKE PHILOSOPHY COURSES IN ANY ORDER

PHIL 3 AESTHETICS 3.0 Units

An introduction to the philosophical analysis of art. Topics include the nature of art and beauty, the value of art, and philosophical methods of evaluating, critiquing, and drawing meaning from artistic works.

STUDENTS MAY TAKE PHILOSOPHY COURSES IN ANY ORDER

PHIL 6 INTRODUCTION TO LOGIC 3.0 Units

An introduction to Logic. This course is designed to develop effective reasoning skills. Valid reasoning through formal deductive logic is emphasized, but the course also covers meaning in language, fallacies, and inductive reasoning methods in philosophy, literature and the sciences.

Recommended Course Preparation: Eligibility for ENG 1A

STUDENTS MAY TAKE PHILOSOPHY COURSES IN ANY ORDER

PHOTOGRAPHY

PHTO 50 INTRODUCTION TO PHOTOGRAPHY 3.0 Units

Introduction to the history and development of photography, basic processes, various types of cameras, materials, basic shooting, processing developing, and printing of photographs.

Students enrolled in PHTO 50 will be assessed a \$20 materials fee at registration.

PHTO 51A INDIVIDUAL PROJECTS A 1.5 Units

Individual projects in digital or film-based photography at the intermediate to advanced level. Development of knowledge and skills acquired in previous or current photography work with emphasis on current projects.

Recommended Course Preparation: PHTO 50 or PHTO 56 with a minimum grade of C

Students enrolled in PHTO 58 will be assessed a \$20 materials fee at registration.

PHTO 51B INDIVIDUAL PROJECTS B 1.5 Units

Continued study on advanced topics of photography and exhibition, installation, and portfolio of photography.

Strongly Recommended: PHTO 51A with a minimum grade of C

Students enrolled in PHTO 58 will be assessed a \$20 materials fee at registration.

PHTO 57 INTERMEDIATE DIGITAL PHOTO 1.5 Units

This course covers digital photography including intermediate and advanced digital image capture assignments, camera use, digital manipulation using software such as Adobe Photoshop, and preparation of image files for display printing and use on the Web.

Strongly Recommended: PHTO 56 with a minimum grade of C

PHTO 58 INTRODUCTION TO VIDEOGRAPHY 3.0 Units

Introduction to the theory and practice of video production and desktop video editing including project production phases, time-based visual and sound design, digitizing footage, video output issues, working creatively in a collaborative environment, industry standards, using a Macintosh computer platform.

Students enrolled in PHTO 58 will be assessed a \$20 materials fee at registration.

PHTO 69 INTERMEDIATE VIDEOGRAPHY 3.0 Units

This course covers intermediate level digital video production to integrate and build upon prior video making skills. emphasis is on creative expression, improving all production values, edited quality of finished presentation, distribution of quality video piece to festivals and the web. Class is taught on the Macintosh computer platform.

Recommended Course Preparation: PHTO 58 with a minimum grade of C

Students enrolled in PHTO 69 will be assessed a \$20 materials fee at registration.

PHYSICS

PHYS 1A GENERAL PHYSICS I 5.0 Units

Introduction to the principles of Newtonian Mechanics and analytical methods of physics using calculus as needed. Topics covered include vectors, kinematics, forces, energy, momentum, rotation, and gravitation.

Prerequisite: MATH 1 with a minimum grade of C

PHYS 1B GENERAL PHYSICS II 5.0 Units

Introduction to fluid dynamics, oscillations, mechanical waves, thermodynamics, light and optics.

Prerequisite: PHYS 1A and MATH 2 with a minimum grade of C

PHYS 1C GENERAL PHYSICS III 5.0 Units

Introduction to electricity and magnetism, circuits, Maxwell's equations and electromagnetic waves.

Prerequisite: PHYS 1A with a minimum grade of C and MATH 3 (May be taken concurrently)

PHYS 1D GENERAL PHYSICS IV 3.0 Units

Introduction to relativity and modern physics, including: introduction to quantum theory; atomic, molecular, nuclear and particle physics; condensed matter physics; astrophysics and cosmology.

Prerequisite: PHYS 1B and PHYS 1C with a minimum grade of C and MATH 5 (May be taken concurrently)

PHYS 2B INTRODUCTION TO PHYSICS II 4.0 Units

This algebra-based course is an introduction to the basic principles

of electricity, magnetism, and modern physics. Topics include electrostatics, magnetism, circuits, electromagnetic waves, optics, relativity, atomic physics, and nuclear physics.

Prerequisite: PHYS 2A with a minimum grade of C

POLITICAL SCIENCE

POLI 7 INTRO TO AMERICAN GOVERNMENT 4.0 Units

Introduction to the principles, problems and basic issues of government with particular emphasis on the national government in the United States, including discussion of the American Constitution, and California state and local government.

Recommended Course Preparation: Eligibility for ENG 1A

POLI 12 INTRO CAL STATE AND LOCAL GOVT 3.0 Units

Organization and operation of government and politics at the state, county and municipal level; emphasis on current issues and the influences of historical, geographical, political, economic and social factors on public policy.

Recommended Course Preparation: Eligibility for English 1A.

POLI 20 COMPARATIVE GOVERNMENT 3.0 Units

Contemporary forms of government, institutions and political problems of selected national governments.

Recommended Course Preparation: POLI 7 with a minimum grade of C Eligibility for ENG 1A

POLI 25 INTRO TO POLITICAL THEORY 3.0 Units

Various theoretical approaches to politics including selected aspects of political thought from ancient times to the present with application to current political thought.

Recommended Course Preparation: Eligibility for ENG 1A, POLI 7 with a minimum grade of C

PSYCHOLOGY COUNSELING

PCN 10 CAREER AND EDUC. PLANNING 2.0 Units

Exploration of the concept of career, educational and life planning focusing on personal career development through self-assessment. Emphasis on clarification of individual interests, values, needs, abilities and decision making styles, investigation of occupational opportunities in the world of work, and introduction to job search strategies, resume writing and interview skills. Designed for those undecided or uncertain about their career and educational plans.

PCN 13 MULTICULTURAL ISSUES: AMERICA 3.0 Units

Exploration of issues relating to the multicultural community in which we live today. Interpersonal relations and communication. Focus on improving individuals understanding of other cultures and how those cultures impact the American lifestyle. Includes exploration of myths and misunderstandings. Discussion of four specific cultures or sub-cultures from the following groups: 1) African-American, 2) Asian-American, 3) Hispanic-American, 4) Native-American, 5) Middle Eastern-American, 6) European-American, 7) Gay/Lesbian American, 8) Disabled American.

PCN 18 UNIVERSITY TRANSFER PLANNING 1.0 Units

Introduction to the resources and planning process needed to ease transition from community college to a four-year college or university. Development of a transfer action plan. Preparation for major and general education requirements. Application cycles and important deadlines. Recommended for those transferring to four-year colleges or universities.

PCN 30 STUDENT SUCCESS: COLLEGE EXP. 3.0 Units

This course explores concepts, knowledge, and skills relevant to college success. Students will engage in critical analysis on a variety of topics, including motivation, decision making, interpersonal communication, multicultural awareness, and learning theory. Problem solving strategies will be applied to areas including goal setting, career development, wellness, and accessing campus resources.

PCN 50 SOCIAL WORK AND H.S. SEMINAR 1.0 Units

This course provides the student who is participating in a supervised field experience in a community organization, agency, or institution with a weekly class meeting that provides the academic element to the experiential course offering. The application of concepts gained in the prerequisite or corequisite course to the field experience will be emphasized. This course is designed to provide the student with an opportunity to develop skills that would facilitate gaining employment in the human services field.

Prerequisite: PCN 5 or PSYC 1 or SOC 1 with a minimum grade of C

Corequisite: PCN 50L Fieldwork course should be taken alongside seminar to reinforce learning objectives.

PCN 50L SOCIAL WORK AND H.S. FIELDWORK 2.0 Units

This course provides an introduction to fieldwork participation in the area of Social Work/Human Services (community organization, agency, or institution) allowing the student to apply knowledge and learn new skills outside of the classroom environment. This course is designed to provide the student with an opportunity to develop skills in preparation for gaining employment in the human services field. Students will be required to participate in a minimum of 120 hours of fieldwork per term.

Prerequisite: PCN 5 or PSYC 1 or SOC 1

Corequisite: PCN 50

This course is to be completed alongside PCN 50- seminar portion of fieldwork placement.

PSYCHOLOGY

PSYC 1 GENERAL PSYCHOLOGY 3.0 Units

Introduces students to the scientific study of behavior and mental processes. Provides an overview of major psychological concepts and theories in such areas as consciousness, learning, memory, motivation, perception, personality, stress, and social behavior.

Recommended Course Preparation: Eligibility for ENG 1A

PSYC 3 INTRO. TO SOCIAL PSYCHOLOGY 3.0 Units

This course will introduce theories and concepts that explain individual behavior in social settings. The topics include research methods, social perception, social cognition, beliefs, prejudice/discrimination, interpersonal relationships, aggression, and group behavior.

Recommended Course Preparation: PSYC 1 with a minimum grade of C

PSYC 4 BRAIN, MIND, AND BEHAVIOR 3.0 Units

Introduction to the field of biopsychology. The biopsychology of cognitive, perceptual, emotional, developmental, and social processes. Includes the biopsychology of personality, gender, emotions, learning, learning disabilities, drugs, neurological and

Scan here to visit the current Spring 2024 class schedule online



developmental disorders, and mental health. Examination of information and theory for practical application.

Prerequisite: PSYC 1 with a minimum grade of C

PSYC 6 ABNORMAL PSYCHOLOGY 3.0 Units

An introduction to mental health and the major mental health disorders in adults and children; includes anxiety, mood, personality, sexual, and psychotic disorders. The course will include the study of the major psychological, biological, and sociocultural models of mental health disorders and their treatment.

PSYC 10 PSYCHOLOGY OF HUMAN SEXUALITY 3.0 Units

Physiological and psychosocial aspects of sexual health in our contemporary society. Understanding the interrelationship of attitude and behavior as it relates to sexual well-being and sexual integrity.

PSYC 12 LIFE-SPAN PSYCHOLOGY 3.0 Units

Introduction to the psychological, physiological, and socio-cultural factors influencing development from conception through death. Emphasis on the process of normal development and its variations. Examination of theoretical models and research for practical application.

PSYC 15 ABNORMAL CHILD PSYCHOLOGY 3.0 Units

An exploration of the emotional, cognitive, developmental, and behavioral problems of childhood and adolescence. Topics include: common stresses and problems of adjustment; the effects of stress, abuse, and traumas on development; mental retardation, autism and other developmental disabilities; normal and abnormal problems of attention, conduct, mood, anxiety, sleep, eating, sex, learning and speech. Examination of theories of cause of mental health problems in children and adolescents and approaches to treatment. Examination of information and theory for practical application.

PSYC 17 PSYCHOLOGY OF SLEEP & DREAMS 3.0 Units

An introduction to the scientific study of sleep and dreams. Major historic, modern, multicultural views and theories of sleep and dreams; research methods in the study of sleep and dreams; the biological basis of sleep and dreams; biological rhythms; individual differences in biological rhythms and their implication for social policies; the stages and cycles of sleep; sleep requirements and changes across the lifespan; the relationship between sleep and daytime alertness, cognitive, emotional, and behavioral functioning, and physical and mental health; societal implications of sleep deprivation in diverse populations; theories of dream content, function, and meaning; dreaming and creativity; lucid dreaming; sleep disorders and their characteristics and treatments. Examination of information and theories for practical application.

PSYC 21 PSYCH. OF RACE AND IDENTITY 3.0 Units

This course is an introduction to the impact of race and ethnicity on identity in the United States, which focuses on how these influence human behavior and shape one's understanding of the world around them. We will study a variety of topics related to race, ethnicity, social and cultural group developmental norms and the extent of influence these norms may have on an individual's worldview. This course seeks to strengthen diversity awareness and knowledge by engaging in difficult discussions surrounding race and identity. This course will review a broad range of theories and research findings regarding race and ethnicity's influence on human behavior and cognitive process. Topics covered include stereotypes, prejudice, discrimination, racism, the intersection between race, ethnicity and other forms of oppression, privilege, and identity development. Students who have completed, or are enrolled in, ETHS 5 may not receive credit.

Recommended Course Preparation: PSYC 1 with a minimum grade of C

PSYC 25 RESEARCH METHODS 4.0 Units

Introduction to the use of the scientific method in the study of human and animal behavior. Coverage of descriptive, experimental, and non-experimental methods commonly used in psychological research. Topics will include ethical principles in research, hypothesis development and testing, observational methods, survey research, the fundamentals of experimental design, basic data analysis, and the presentation of research findings.

Prerequisites: PSYC 1 with a minimum grade of C and MATH 40 with a minimum grade of C

RELIGIOUS STUDIES

RELS 1 RELIGIONS OF THE WORLD 3.0 Units

This course is an introduction to select religious traditions and cultures through exploring the history and beliefs of different religions. This course will also examine classic sacred texts and a variety of sacred practices. Religions studied include Shamanistic/Indigenous Religions, Hinduism, Buddhism, Jainism, Sikhism, Taoism, Confucianism, Judaism, Christianity, and Islam.

STUDENTS CAN TAKE RELIGIOUS STUDIES CLASSES IN ANY ORDER

RELS 3 INTRO TO WOMEN'S SPIRITUALITY 3.0 Units

An interdisciplinary and cross-cultural examination of women's spirituality with particular reference to women's contributions and influence in redefining feminine aspects of the divine. Examines the use of feminine experience as a primary construct for understanding the connection between women's spirituality and the sacred. This course will also explore how issues of gender, culture, and identity influence women's religious experiences. Explores religious texts, rituals, music, poetry and film.

SOCIOLOGY

SOC 1 PRINCIPLES OF SOCIOLOGY 3.0 Units

The sociological perspective: scientific study of human interaction and society as a whole with emphasis on the impact of groups on social behavior, systematic examination of culture, social organization, and methodology.

SOC 3 INTRO TO RACE AND ETHNICITY 3.0 Units

Racial and ethnic relations in the United States. Examines the cultural, political, and economic practices and institutions that support or challenge racism, racial and ethnic inequalities, as well as patterns of interaction between various racial and ethnic groups. Students who have completed, or are enrolled in, ETHS 6 may not receive credit.

Recommended Course Preparation: SOC 1 with a minimum grade of C

SOC 6 SOCIAL PROBLEMS 3.0 Units

An identification and analysis of contemporary social problems including (1) the role of power and ideology in the definition of social problems, (2) their causes and consequences, (3) evaluations of proposed solutions, and (4) methods of intervention. Topics will vary.

SOC 11 SOCIOLOGY OF GENDER 3.0 Units

This course examines the social construction of masculinity and femininity historically and cross-culturally. It analyzes the impact of economic and political change on gender expectations and practices. This class focus includes both macro-analyses of how

institutions shape gender and microanalyses of how individuals “do” or practice gender.

SOC 13 RESEARCH METHODS 4.0 Units

This course orients students to the methods of data collection and analysis used by sociologists. Instruction includes an overview of sociological theory, instruction on experimental methods, surveys, interviews, field research, participant observation, demographic methods, and comparative historical approaches.

Prerequisite: SOC 1 with a minimum grade of C

Recommended Course Preparation: MATH 40 with a minimum grade of C

SPANISH

SPAN 1A BEGINNING SPANISH 5.0 Units

This introductory level course offers a balanced approach to language and culture. It will enable students to begin speaking, reading and writing elementary level Spanish as well as understanding the spoken language as they explore the culture and countries of the Spanish-speaking world. Students are introduced to concepts of grammar, vocabulary and verb tenses in a variety of auditory, visual and written contexts.

Recommended Course Preparation: ENG 1A with a minimum grade of C

SPAN 1B ELEMENTARY SPANISH 5.0 Units

This is the second semester of the introductory level course. It continues to offer a balanced approach to language and culture. It enables students to continue learning to speak, read and write elementary level Spanish as well as to understand the spoken language as they explore the culture and countries of the Spanish-speaking world. Students continue to review and improve upon concepts of grammar, vocabulary and verb tenses in a variety of auditory, visual and written contexts. The course will continue to examine the culture of the Spanish-speaking world.

Prerequisite: SPAN 1A with a minimum grade of C

SPAN 2A INTERMEDIATE SPANISH I 4.0 Units

This course covers a review of grammar, reading of contemporary literature, practice in conversation and composition, and discussion of cultural topics.

Prerequisite: SPAN 1B with a minimum grade of C

SPAN 2B INTERMEDIATE SPANISH II 4.0 Units

A course covering the reading of contemporary works, advanced review of grammar emphasis on speaking and composition, and further discussion of cultural topics.

Prerequisite: SPAN 2A with a minimum grade of C

THEATER ARTS

THEA 1A THEORY/PRACTICE OF ACTING I 3.0 Units

This course prepares a student to apply basic acting theory to performance and develops the skills of interpretation of drama through acting. Special attention is paid to skills for performance: memorization, stage movement, vocal production, and interpretation of text. An introduction to the techniques and theories of acting, explored through improvisation, exercises and scene study. Students should be able to demonstrate the following skills: development of the physical and psychological resources for acting including relaxation, concentration, creativity, believability, and commitment.

Recommended Course Preparation: ENG 1A or ENG 1AEX with a minimum grade of C

THEA 1B THEORY/PRACTICE OF ACTING II 3.0 Units

Continued exploration of the theory and practice of acting, focusing on more complex characterization and character analysis. Introduction to theatrical styles and period acting with emphasis on monologues and scenes.

Prerequisite: THEA 1A with a minimum grade of C or an equivalent acting class or acting performance experience.

THEA 5 THEATER FOR YOUNG AUDIENCES 3.0 Units

Introduction to the history, theory, and techniques of theater for young audiences. Creation, including possible props, puppets, masks, and costumes, and performance of a theatrical production to be performed for local K-12 students. All enrolled will be a part of the production and will learn aspects of a show for public performance for young audiences. Casting is subject to audition.

Recommended Course Preparation: THEA 1A with a minimum grade of C

THEA 48A TECH THEATER PROD- BEGINNING 3.0 Units

Students will gain practical experience in the application of production responsibilities in any of the following: stage management, house management, construction, scenery, properties, costume, lighting, sound and running crews. Enrollment is for the duration of the semester.

Recommended Course Preparation: MATH 107 and THEA 50 with a minimum grade of C

THEA 48B TECH THEATER PROD-INTERMEDIATE 3.0 Units

Participation in scheduled productions and events as crew members and/or construction of said productions technical elements, including lighting and sound implementation. Enrollment is for the duration of the semester. Students may participate in the design and board operation of multiple productions or events per semester.

Prerequisite: THEA 48A with a minimum grade of C

Recommended Course Preparation: MATH 107 with a minimum grade of C

THEA 48C TECH THEATER PROD- ADVANCED 3.0 Units

Participation in scheduled productions as assistant stage managers or assistant designers of said productions technical elements, including scenic, costume, lighting and sound design. Enrollment is for the duration of the semester. Students may participate in more than one production per semester, as needed.

Prerequisite: THEA 48B and THEA 50L or THEA 51 or MUS 35 or THEA 52 with a minimum grade of C

Recommended Course Preparation: MATH 107 or MATH 107B with a minimum grade of C

THEA 48D TECH THEATER PROD-CAPSTONE 3.0 Units

Participation in scheduled productions as manager of productions technical elements, which may include stage management, publicity management, or designer’s apprentice in lighting, sound, costume, or scenic design. Enrollment is for the duration of the semester. Students may participate in more than one production or event per semester.

Prerequisite: THEA 48C, THEA 50L or MUS 35 or THEA 51 or THEA 52 with a minimum grade of C

THEA 50L INTRODUCTION TO STAGE LIGHTING 3.0 Units

This course involves the study and execution of stage lighting with emphasis on equipment, control, and their relationship to

Scan here to visit the current Spring 2024 class schedule online



design. Introduction to stage lighting design. Physics of light, color, electricity; components of basic lighting technology; comprehensive overview of the art of theater lighting design.

Strongly Recommended: THEA 50 with a minimum grade of C

THEA 53 SCRIPT ANALYSIS 3.0 Units

Develops critical thinking, analysis, and writing skills as they apply to the exploration of the principles, theories and techniques of play script analysis for theatrical production. Class content includes the historical and cultural context of various kinds of script; genre and form; narrative and plot analysis; linguistic analysis; interpreting stage directions; and identification of main themes. Emphasis on effective written communication in literature. Research required.

Prerequisite: ENG 1A or ENG 1AEX with a minimum grade of C

THEA 54 SHAKESPEARE 3.0 Units

Study and performance of classical Shakespearean texts (monologues and dialogues), with a focus on the Elizabethan world as it applies to performance. Students will come to understand the works of William Shakespeare through active performance techniques as well as traditional literary analysis.

Prerequisite: THEA 1A with a minimum grade of C

Recommended Course Preparation: THEA 1B with a minimum grade of C

THEA 56 ACTING FOR THE CAMERA I 3.0 Units

Introduction to the principles and techniques of acting on camera and voice-over acting. This course explores acting techniques for industrials, commercials, film and television as well as voice-over for television, radio, cartoons, and more.

THEA 57A PERFORMANCE PROD- INTRODUCTION 3.0 Units

This course provides instruction and supervised participation in theatre rehearsal and performance. On stage participation in cast of scheduled main stage production. Enrollment is for the duration of the production.

This production is by audition only and will require rehearsals and performances outside of the listed course hours. Auditions are scheduled for November 2023. For more information on auditions and rehearsals, please visit the audition page at <http://laspositascollege.edu/theater/auditions.php> or contact producer Titian Lish at tlish@laspositascollege.edu

THEA 57B PERFORMANCE IN PROD. BEGINNING 3.0 Units

As a continuation of THEA 57A, students will participate in the cast of a scheduled main stage musical production. Emphasis will be on character development, objectives, and actions.

Prerequisite: THEA 57A with a minimum grade of C (May be taken concurrently)

THEA 57C PERFORMANCE PROD- INTERMEDIATE 3.0 Units

This course is a continuation of THEA 57B. Student will participate in the cast of a scheduled main stage musical production. This course will focus on rehearsal technique, personal creative exploration, and ensemble building and motivated performance response.

Prerequisite: THEA 57B with a minimum grade of C

THEA 57D PERFORMANCE PROD- ADVANCED 3.0 Units

As a continuation of THEA 57C, students will continue to develop onstage with participation in the cast of the scheduled main stage production. This course will emphasize complexity and polish in performance, personal and creative development as a theater professional, and development as a vocal musician.

Prerequisite: THEA 57C with a minimum grade of C

TUTORING

TUTR 17A TUTORING THEORY & PRACTICE I 0.5 Units

Training for college tutors to acquire specific skills and techniques for tutoring in academic and vocational subject areas, and basic skills. The course will provide a conceptual framework of tutoring to guide students in leading effective tutoring sessions.

TUTR 17B TUTORING THEORY & PRACTICE II 0.5 Units

Intermediate training class for college tutors. Tutors will acquire specific skills and techniques for tutoring in academic subjects, vocational subjects and basic skills. Required course for second semester tutors participating in the Las Positas College Tutorial Program.

Prerequisite: TUTR 17A with a minimum grade of C

TUTR 17C TUTORING THEORY & PRACTICE III 0.5 Units

Advanced training for college tutors to obtain skills and techniques in academic and vocational subject areas and basic skills remediation. Emphasis upon leading group tutoring sessions and mentoring new tutors. Required course for third semester tutors participating in the Las Positas College Tutorial Program.

Prerequisite: TUTR 17B with a minimum grade of C

VITICULTURE AND WINERY TECH

VWT 2 WORLD WINES: OLD WORLD 3.0 Units

This course is a comprehensive exploration of "old world" wines. The winemakers of the "old world" have been creating distinctive wines for millennia and now have embraced modern techniques and equipment to add another facet to the wines of Europe and beyond. Explore the history of wine regions, wine cultures, and the varied wines of France, Italy, Spain, Portugal, Germany, and Eastern Europe.

Students under the age of 21 must have a declared major of either viticulture and/or enology to participate in any tasting activities as stated in the California State Assembly Bill 1989.

VWT 10 INTRODUCTION TO VITICULTURE 3.0 Units

This is an introduction to general viticulture covering the fundamental principles of the biology and culture of the grapevine. This includes taxonomy, morphology, physiology, distribution, domestication, utilization, propagation, production systems, harvesting, and storage and processing of grapes, with a brief overview of wine making. The class explores climate and soil preferences of *Vitis vinifera*, vineyard establishment, and training young vines. Cultural practice lectures will focus on canopy management disciplines, irrigation strategies, fertilization, pest and disease control, cover cropping and pruning. There will be practical experience workshops in the Campus Hill Vineyard. Successful completion of course should prepare students for upper division courses in viticulture.

Students under the age of 21 must have a declared major of either viticulture and/or enology to participate in any tasting activities as stated in the California State Assembly Bill 1989.

VWT 20 INTRODUCTION TO ENOLOGY 3.0 Units

This course is an overview of the history of wine, modern viticulture and enology principles and practices, the science of fermentation, and standard winery operations. There is a primer on grape varieties and wine styles produced in major wine-producing regions of the world including California which will focus on regional stylistic expression of specific, heritage varieties. Instruction covering the

physiology of wine consumption will precede practical exercises which will include the sensory evaluation of wines.

Students under the age of 21 must have a declared major of either viticulture and/or enology to participate in any tasting activities as stated in the California State Assembly Bill 1989.

VWT 35 LANDSCAPE/VINEYARD PEST MGT. 3.0 Units

This course covers concepts of plant pathology, entomology, and weed science which are studied in order to identify symptoms, diagnose problems, and determine methods of controlling plant diseases, insects, and weed pests. Also included is the study of the identification and biology of common vineyard, landscape and other horticultural crop pests and diseases. Materials and instruction is provided for techniques and strategies for insects, weeds and diseases, including bio-control, sustainable agriculture practices and integrated pest management. In addition to pesticide use, safety and compliance, there is a focus on preparation for the California State Qualified Applicators license. Students that take HORT 53 may not receive credit for VWT 35.

VWT 47 WINE REGIONS WINES OF CALI 3.0 Units

Introduction to wines produced in California by region, including history, viticultural practices and winemaking styles. There is a strong emphasis on the sensory evaluation of representative California wines. There is a materials fee associated with this class.

Students under the age of 21 must have a declared major of viticulture and/or enology to participate in any tasting activities as stated in the California State Assembly Bill 1989.

This course has a \$150 materials fee.

WELDING TECHNOLOGY

WLDT 10 MACHINING- METAL TRADES 4.0 Units

This course is intended to show how machine tools are used in the metal trades and manufacturing, as well as how machine tools operate and when to use one particular machine instead of another. The advantage and disadvantage of various machining techniques as well as their application in the fabrication process are explored. Students will learn the use of drawings, hand tools, precision measuring tools, drilling machines, grinders, lathes, milling machines, and other specialized tools used to shape and finish metal and nonmetal parts. Additive and subtractive manufacturing techniques as well as related processes are explored.

WLDT 61AL BEG. SMAW AND FCAW SKILLS LAB 2.0 Units

Skills of Shielded Metal Arc (SMAW) and Flux-Core Arc (FCAW) welding in the flat and horizontal positions to American Welding Society code specifications. Oxy-fuel flame, plasma, and carbon arc cutting. Safe use and handling of welding equipment and consumables.

Corequisite: WLDT 61A or WLDT 61B.

WLDT 61B ADV. SMAW AND FCAW THEORY 1.0 Units

Theory and safety of Stick (SMAW) and Flux-core Arc (FCAW) welding of steel, flame cutting, plasma and carbon arc cutting. American Welding Society nomenclature, electrode and wire selection, job opportunities. Blueprint reading, welding symbols for welders and hazardous material regulations.

Corequisite: WLDT 61AL or WLDT 61BL

WLDT 61BL ADV. SMAW AND FCAW SKILLS LAB 2.0 Units

Advanced skills in Shielded Metal Arc (SMAW) and Flux Cored Arc (FCAW) welding of steel in the horizontal, vertical and overhead positions to A.W.S. Codes. Safety and proper use of SMAW, FCAW, oxy-fuel cutting and plasma arc cutting equipment. Blueprint usage in the welding shop environment.

Prerequisite: WLDT 61AL completed with a minimum grade of C

Corequisite: WLDT 61A or WLDT 61B

WLDT 62AL BEG. GTAW AND GMAW SKILLS LAB 2.0 Units

Skills of TIG (GTAW) and MIG (GMAW) welding of ferrous and non-ferrous alloys in the flat and horizontal positions to A.W.S. codes. Safety and proper use of TIG and MIG equipment, oxy-fuel welding and cutting, plasma cutting. Blueprint usage in welding shop environment.

Corequisite: WLDT 62A or WLDT 62B

WLDT 62B ADV. GTAW AND GMAW THEORY 1.0 Units

Theory of fuel and inert gas welding of Non-Ferrous alloys, Oxy-Fuel welding, Oxy fuel brazing, flame cutting, and plasma cutting. Gas Tungsten Arc (GTAW) and Gas Metal Arc (GMAW) welding equipment and supplies. Nomenclature and metallurgy of Non-Ferrous alloys. Introduction to blueprint reading and welding symbols. Hazardous material regulations and safety data sheets.

Corequisite: WLDT 62AL or WLDT 62BL.

WLDT 62BL ADVANCED GTAW/GMAW SKILLS LAB 2.0 Units

Advanced skills in Gas Tungsten Arc (GTAW) and Gas Metal Arc (GMAW) welding of ferrous and non-ferrous alloys in the horizontal, vertical and overhead positions to A.W.S. codes. Safety and proper use of TIG and MIG equipment, oxy-fuel welding and cutting, plasma cutting. Blueprint usage in welding shop environment. Pipe and tubing fit-up and welding.

Prerequisite: WLDT 62AL with a minimum grade of C

Corequisite: WLDT 62A or WLDT 62B

WLDT 63 WELDING LAYOUT AND FITTING 2.0 Units

Interpretation of welding blueprints by making welding layouts and weldment fitups. Current methods, practices, and recommended procedures. Use of jigs, fixtures, holding devices, and welding sequences. Methods of straightening and restoring dimensions to finished product. Laboratory includes SMAW, GMAW, GTAW, and FCAW welding, plasma and oxy-fuel cutting.

Recommended Course Preparation: WLDT 61BL or WLDT 62BL with a minimum grade of C

WLDT 66 WELDING INSPECTION & TESTING 2.0 Units

Theory and skills in performing inspections and tests using American Welding Society (AWS) codes and their role in welding inspection. The role and duties of the Certified Welding Inspector (CWI).

Strongly Recommended: WLDT 61AL or WLDT 62AL with a minimum grade of C

WLDT 67A WELDING SKILLS LAB 2.0 Units

Development and improvement of skills in Shielded Metal Arc (SMAW), Flux Cored Arc (FCAW), Gas Metal Arc (GMAW), and Gas Tungsten Arc (GTAW) welding.

Recommended Course Preparation: WLDT 61AL or WLDT 62AL or WLDT 70 or WLDT 71 with a minimum grade of C

Students enrolled in 67A lab class will be assessed a \$40 materials fee at registration.

WLDT 67B ADVANCED WELDING SKILLS LAB 2.0 Units

Advanced development and improvement of skills in Shielded Metal Arc (SMAW), Flux-core (FCAW), Gas Metal Arc (GMAW), and Gas Tungsten Arc (GTAW) welding.

Recommended Course Preparation: WLDT 67A with a minimum grade of C

Students enrolled in 67B lab class will be assessed a \$40 materials fee at registration.

WLDT 68 CERTIFICATION PREPARATION 2.0 Units

Welding skills preparation for certification testing. Theory of American Welding Society D1.1, American Society of Mechanical Engineers Section IX and American Petroleum Institute 1104.

Recommended Course Preparation: WLDT 61AL or WLDT 61BL or WLDT 62AL or WLDT 62BL or WLDT 69A or WLDT 69B with a minimum grade of C

WLDT 69A BEGINNING PIPE WELDING 3.0 Units

Theory and practical application of: pipe joint preparation and design, API (American Petroleum Institute) and AWS (American Welding Society) welding codes specification for pipe and pipe fittings, analysis of joint configuration, plasma and flame cutting of pipes, wire and electrodes selections, beginning of pipe welding blue print and welding symbols, SMAW, GMAW, FCAW, and GTAW of pipe joints, non-destructive and destructive test and qualitative concepts of evaluation. Welding in the 1G and 2G positions.

Prerequisite: WLDT 61BL or WLDT 62BL with a minimum grade of C

Students enrolled in 69A lab class will be assessed a \$100 materials fee at registration.

WLDT 69B ADVANCED PIPE WELDING 3.0 Units

Theory and practical application of pipe joint preparation and design, API (American Petroleum Institute) and AWS (American Welding Society) welding codes specifications for pipe and pipe fittings, analysis of joint configuration, plasma and flame cutting of pipes, wire and electrodes selections, beginning of pipe welding blue print and welding symbols, SMAW, GMAW, FCAW and GTAW of pipe joints, non-destructive and destructive test and qualitative concepts of evaluation. Welding in the 5G and 6G positions.

Prerequisite: WLDT 69A completed with a minimum grade of C

Students enrolled in 69B lab class will be assessed a \$100 materials fee at registration.

WLDT 70 INTRODUCTION TO WELDING 2.0 Units

Basic skills in Shielded Metal Arc (SMAW), Gas Tungsten Arc (GTAW), Gas Metal Arc (GTAW) and Flux Core Arc (FCAW) welding. Oxy-fuel welding and thermal cutting. Emphasis on safety, proper usage, theory and care of welding equipment.

WOMENS STUDIES

WMST 2 GLOBAL PERSPECTIVE OF WOMEN 3.0 Units

Examines the cultural, historical, political and economic experiences of women globally. Introduces feminist perspectives on a wide range of issues affecting women including globalization, war, education, work, family and religion in Asia, Africa, the Middle East and Latin America.

WORK EXPERIENCE

WRKX 94 OCCUPATIONAL WORK EXP/INTERN. 1.0-8.0 Units

This course of supervised employment provides students with the opportunity to earn college credit for developing marketable skills while working in their major field of study. Students working in a part-time or full-time, paid or unpaid internship or position related to their major field of study will contract, in collaboration with their work supervisor and instructor, to set measurable, achievable goals; accomplish new or expanded learning objectives; and broaden work skills and experiences. Students will apply discipline-specific knowledge, skills, and abilities gained in the classroom. Students can earn 1 to 8 units per semester for a maximum of 16 units of Cooperative Work Experience, which includes General Work

Experience and Occupational Work Experience/Internship. Students must work 75 paid hours or 60 unpaid hours per unit earned during the semester.

WRKX 95 GENERAL WORK EXPERIENCE 1.0-6.0 Units

This course of supervised employment provides students with the opportunity to earn college credit while working and developing desirable work habits, attitudes, and skills. Students working in any part-time or full-time, paid or unpaid position will contract, in collaboration with their work supervisor and instructor, to set measurable, achievable goals; accomplish new or expanded learning objectives; and broaden work skills and experiences. The work experience need not be related to the students' educational goals. Students can earn 1 to 6 units per semester for a maximum of 16 units of Cooperative Work Experience, which includes General Work Experience and Occupational Work Experience/Internship. Students must work 75 paid hours or 60 unpaid hours per unit earned during the semester.

Mathematics Pathway to Business/STEM Transfer

Students are encouraged to enroll directly into a transfer-level Math course. Research has shown students are more likely to succeed in their Math class when they enroll in concurrent support and/or Math Jam course. Noncredit courses are FREE!

BUSINESS/STEM TRANSFER LEVEL COURSES

STEM is Science, Technology, Engineering, and Mathematics

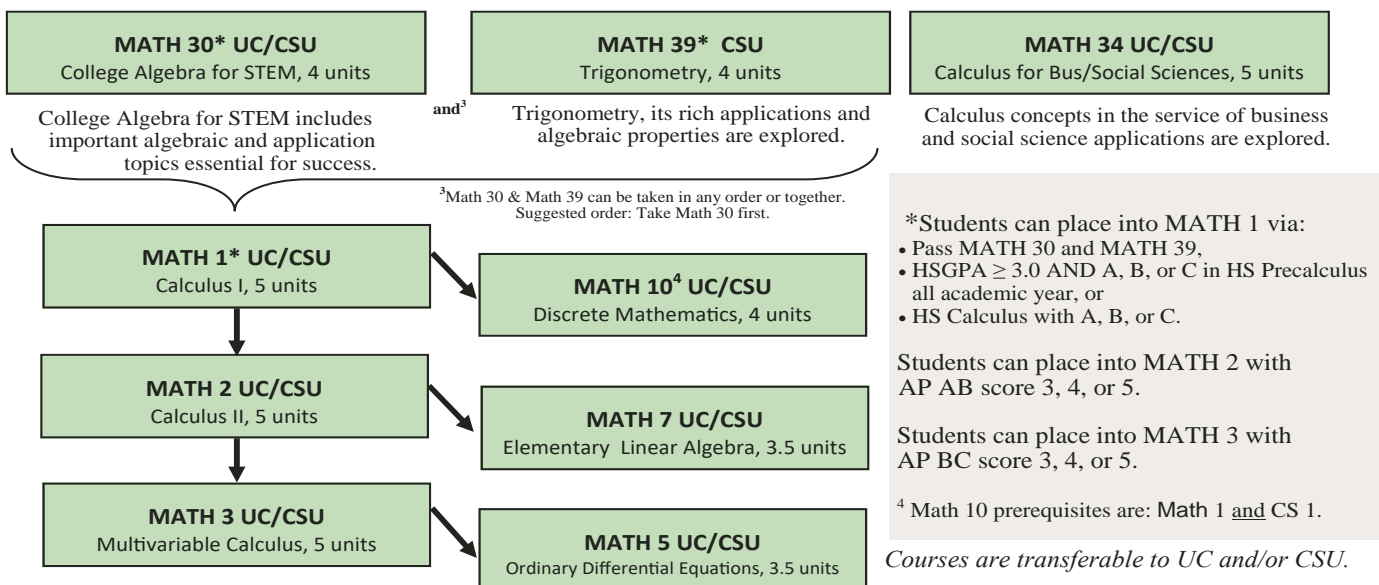

Enroll in your Math class with confidence!

MATH JAM BOOTCAMP COURSES
Award-winning, 1-week before the semester starts, & tuition-free!
 Offered the week before the Fall and Spring semesters. Innovative learning interventions help you prepare for upcoming mathematic courses. Proven to increase student success and retention rates!

NMAT 265
 Math Jam for BSTEM (Business Calculus, College Algebra, and Trigonometry)

MATH 66* & 67* 1 unit
 Math Jam for Calculus I & II respectively
 * Offered for credit only

CONCURRENT SUPPORT COURSES
Support during the semester, offered for credit or tuition free (noncredit)!
 Aligned with your math course and designed with innovative strategies to provide math and learning while you are taking your math class.

NMAT 201C or MATH 101C
 Concurrent Support for BSTEM (Business Calculus, College Algebra, and Trigonometry)

MATH 66C* & 67C* 1 unit
 Concurrent Support for Calculus I & II respectively
 * Offered for credit only

For more information, visit www.laspositascollege.edu/MathJam

What does the RESEARCH say?
 LPC Math Jam students have ~10% higher success rate in their next math course compared students who did not attend Math Jam!

Concurrent Support WORKS. Statewide data shows that students are more likely to succeed with concurrent support.

- Starting one remedial course below college statistics.
- Enrolling directly into transfer-level course.
- Enrolling directly in transfer-level-course with concurrent support.

NMAT courses are tuition-free, noncredit mathematics courses. Students may enroll as many times as desired. NMAT 250/255 students may petition to receive credit by examination.

Mathematics Pathway to Liberal Arts Transfer

Students are encouraged to enroll directly into a transfer-level Math course. Research has shown students are more likely to succeed in their Math class when they enroll in concurrent support and/or Math Jam course. Noncredit courses are FREE!

LIBERAL ARTS TRANSFER LEVEL COURSES

MATH 40 UC/CSU
Statistics & Probability, 4 units

Statistics & Probability introduces topics related to the analysis and presentation of real-world data. Students will apply concepts to draw conclusions and make predictions from data.

MATH 47 UC/CSU
Math for Liberal Arts, 3 units

Math for Liberal Arts surveys a range of math concepts not typically seen in earlier classes. Students will engage with a variety of interesting topics relating to our world.

MATH 33 UC/CSU
Finite Mathematics, 4 units

Finite Math is a survey course in the context of business and every day applications, including financial math, optimization and probability.

MATH 27 UC/CSU
Number Systems for Educators, 3 units

Number Systems for Educators develops quantitative reasoning skills through in-depth, integrated explorations of topics, including real number systems and subsystems. Emphasis is on comprehension and analysis.

Enroll in your Math class with *confidence!*

**MATH JAM
BOOTCAMP COURSES**

Award-winning, 1-week before the semester starts, & tuition-free!

Offered the week before the Fall and Spring semesters. Innovative learning interventions help you prepare for upcoming mathematic courses. Proven to increase student success and retention rates!

NMAT 264
Math Jam for SLAM
(Statistics, Liberal Arts Math)



**CONCURRENT
SUPPORT COURSES**

NEW! Jam all semester long with RECOMMENDED support during the semester.

Offered for credit or tuition-free (noncredit). Aligned with your math course and designed with innovative strategies to provide math and learning support while taking your math class.

NMAT 200C or MATH 100C
Concurrent Support for SLAM
(Statistics, Liberal Arts Math)

For more information, visit
www.laspositacollege.edu/MathJam

What does the RESEARCH say?

LPC Math Jam students have ~10% higher success rate in their next math course compared students who did not attend Math Jam!

Concurrent Support WORKS. Statewide data shows that students are more likely to succeed with concurrent support.

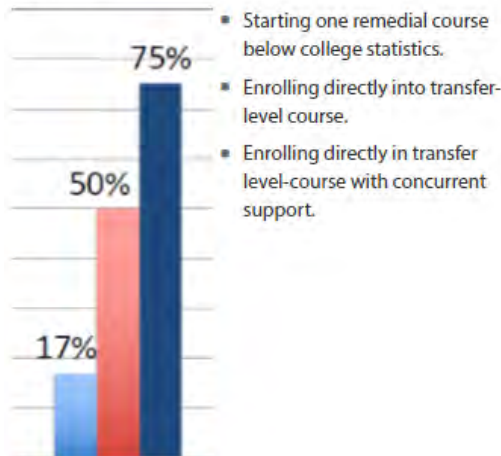

Not sure what course to take? Math faculty and counselors are here to help you.

FEES & PAYMENT POLICY

FEE	AMOUNT	DESCRIPTION <i>(NOTE: Fees are subject to change without notice)</i>
ENROLLMENT FEE	\$46 per unit	The enrollment fee for California residents, except those exempt by law, is \$46 per unit.
NONRESIDENT TUITION	\$360 per unit	Nonresidents of California are required to pay a tuition fee of \$360 per unit in addition to the enrollment fee (\$46 per unit) and other college fees. A California Nonresident Tuition Exemption may be granted to certain nonresident students who meet the exemption requirements. Contact the Admissions and Records Office for information.
INTERNATIONAL STUDENT TUITION	\$360 per unit	The tuition fee for international students, non-immigrant aliens or students on other types of visas is \$360 per unit, in addition to the enrollment fee (\$46 per unit) and other college fees. Failure to meet payment deadlines may jeopardize your F-1 status.
STUDENT HEALTH SERVICES FEE	\$21 per semester \$18 per Summer	Las Positas College has a mandatory student health services fee of \$21 for Fall and Spring semesters, and \$18 for Summer term. This fee is used to support health services for all enrolled students. Information on exemptions may be obtained by contacting the Admissions and Records Office.
STUDENT REPRESENTATION FEE	\$2 per term	Students are charged a mandatory fee of \$2 per term to support student advocacy activities. To opt-out of this fee, students must complete the opt-out form by logging on to CLASS-web and submitting the form by February 4, 2024 for Spring 2024.
STUDENT ACTIVITIES FEE	\$10 per semester	An optional fee of \$10 will be charged each semester. These fees are used to support Student Life through events and programs sponsored by our Las Positas College Student Government, Inter-Club Council, and recognized student clubs.
PARKING FEE	\$3 daily \$20 Summer \$45 Fall & Spring	Parking at Las Positas College is by permit only. Mandatory daily permits can be purchased for \$3 from dispensers located in the parking lots. Permits for automobiles can be purchased online via CLASS-Web or The ZONE for \$45 for Spring and Fall semesters, \$20 for Summer. (Motorcycles - \$20). A reduced term parking fee of \$30 is available for California College Promise Grant (formerly BOG Fee Waiver) students.
TRANSPORTATION FEE	\$9/\$8 per semester	All students are charged a mandatory transportation fee of \$9 (enrolled in six or more units), or \$8 (enrolled in less than six units) per semester. As a result, students are able to ride Wheels buses throughout the semester without having to pay the ridership fare. Contact the Student Life Office for more information.

NELNET TUITION PAYMENT PROGRAM

Avoid being dropped from classes! Las Positas College makes the cost of education more manageable. It's convenient, interest-free, and affordable!

Please note: The Nelnet Tuition Payment Program is available for Fall and Spring terms only.

ADVANTAGES

- Easy online enrollment via CLASS-Web
- Monthly Payment Plan
- Flexible payment options
- No interest

PAYMENT METHODS

- Automatic bank payment (ACH)
- Credit card/debit card

COST TO PARTICIPATE

- \$25 subscriber fee per semester
- \$30 returned payment fee if a payment is returned



SIMPLE STEPS TO ENROLL

- Click on CLASS-Web
- Choose Sign On to CLASS-Web and log in
- Click on the e-Cashier link located on the Pay Fees Online/Registration Fee Assessment Page

MY PAYMENT PLAN

If you have questions about your agreement or need to make a change to your address, telephone number or account number, please visit the following link:

<http://mycollegepaymentplan.com/laspositas/>

Please be sure to have your confirmation email available before logging in. You will receive your confirmation email one business day after submitting your agreement.

For additional information, call us at 800.609.8056. Customer service representatives are available 24/7.

FEES & PAYMENT POLICY

COURSE MATERIALS FEES

The following chart represents an inventory of Las Positas College courses that have materials, facilities, or certification fees assessed in addition to enrollment fees.

DISCIPLINE	COURSE	TYPE	FEE AMT
Emergency Medical Services	EMS 30	Certification	\$7
Emergency Medical Services	EMS 70A, 70B	Certification	\$4
Fire Service Technology	FST 12	Certification	\$675
Fire Service Technology	FST 20, 21, 22, 23	Materials	\$140
Fire Service Technology	FST 25	Materials	\$14
Kinesiology	KIN 14	Materials	\$22
Kinesiology	KIN 15	Materials	\$27
Kinesiology	KIN 17, LG	Materials	\$35
Kinesiology	KIN LG	Materials	\$35
Photography	PHTO 50, 51, 56, 57, 58, 60, 64A, 68, 69	Materials	\$20
Viticulture & Winery Tech	VWT 25	Materials	\$100
Viticulture & Winery Tech	VWT 1, 2, 45, 47, 55	Materials	\$150
Welding Technology	WLDT 61AL, 61BL	Materials	\$70
Welding Technology	WLDT 62AL, 62BL	Materials	\$75
Welding Technology	WLDT 63	Materials	\$30
Welding Technology	WLDT 66	Materials	\$25
Welding Technology	WLDT 67A, 67B, 68	Materials	\$40
Welding Technology	WLDT 69A, 69B	Materials	\$100
Welding Technology	WLDT 70, 71	Materials	\$60

NOTE: Materials fees are subject to change without notice. Please check the website for updated information.

PRINT FEE CARDS

A Print Fee Card is required to print from college computers. Cards may be purchased with a \$1 bill (only), or value added to a card with \$1, \$5, or \$10 bills (only) using vending machines in the Library or the Computer Center on the second floor of Building 2100 in Room 21206. Discount, high-volume Print Fee Cards are available from the LPC Bookstore (cash or card sales) or from the vending machine (cash only) in the lobby of Building 1600.

STUDENT FEE PAYMENT POLICY

<http://www.laspositascollege.edu/admissions/fees.php>

Fees must be paid in full by the scheduled payment due date or you will be dropped from your classes. Enrollment is conditional. The College reserves the right to cancel your registration. Fees can be paid by the following payment methods:

- **Online** - use your credit card by logging into CLASS-Web.
- **Mail** - send a check or money order for full payment. **DO NOT SEND CASH!**
- **In-person** - pay by cash, check or credit card at the Admissions and Records Office.
- **NELNET** - sign up for our online payment plan available for Spring and Fall terms only - see page 66 for details.

AFTER REGISTERING FOR CLASSES

The College does not issue billing statements after registration. It is up to the student to view their balance on CLASS-Web and pay any fees due. Note: Your enrollment is conditional until fees have been paid in full.

IMMEDIATE TEMPORARY NONRESIDENT TUITION EXEMPTION

Per AB 2210, Education Code section 68075.65

Education Code section 68075.65 grants an immediate nonresident tuition fee exemption to eligible Special Immigrant Visa (SIV) holders and refugee students who settled in California upon entering the United States. This exemption is granted for one year from the date the student settled in California upon entering the United States.

This exemption applies to the following:

- Iraqi citizens or nationals (and their spouses and children) who were employed by or on behalf of the United States Government in Iraq (Pub.L. No. 110-181, § 1244)
- Afghan and Iraqi translators (and their spouses and children) who worked directly with the United States Armed Forces (Pub.L. No. 109-163, § 1059)
- Afghanistan nationals who were employed by or on behalf of the U.S. government or in the International Security Assistance Force (ISAF) in Afghanistan (Pub.L. No. 111-8, § 602)
- Refugee students admitted to the United States under Section 1157 of Title 8 of the United States Code

ENROLLMENT FEE REFUND POLICY

Students may request a refund of enrollment fees as long as the student withdraws from the class during the first two weeks of class for a regular term class, or by the 10% point of the length of a short-term class. **Refunds are not automatic.** You must drop your class first. Requests for refunds must be filed by June 30 for the academic year.

A student who must withdraw for military purpose shall be refunded 100% of the fees paid, regardless of the date of withdrawal. In this case, requests for refunds made after the end of the academic year will be honored.

To apply for an enrollment fee refund, file a Request for Refund form at the Admissions and Records Office. No refunds will be given to students who withdraw from classes after the no-grade-of-record (NGR) deadline.

A \$10.00 processing fee will be subtracted from each enrollment fee refund with the exception of classes cancelled by the College.

The Student Representation Fee, Student Health Services Fee, Transportation Fee, and Student Activities Fee are not refundable.

Refund checks will be sent by mail approximately 6 weeks after the NGR deadline.

In addition to the above, Nonresident and International tuition refunds will be given as follows:

- Prior to the first day of instruction - 90%
- During the first week of instruction - 75%
- After the first week of instruction - No refund
- For refund deadlines, see the Academic Calendar.

RETURNED CHECK POLICY

According to California Civil Code Section 1719, the Chabot-Las Positas Community College District will assess a service charge of \$25 for the first check passed on insufficient funds and a \$35 charge for each subsequent check passed on insufficient funds.

COLLECTION POLICY

Chabot-Las Positas Community College District may refer a student's outstanding debt to a collection agency and/or the State of California Franchise Tax Board (FTB) for collection. Once referred, additional fees may apply and credit rating may be affected. If debt is referred to the FTB, amounts owed may be deducted from a student's state tax refund, California lottery prize, or unclaimed property.

FINANCIAL AID

FINANCIAL AID INFORMATION

The Financial Aid Office provides fee waivers, grants, scholarships, student loans, and work-study to eligible students. All students are encouraged to apply for financial aid and scholarships. Nearly 50% of our students are eligible for some kind of free financial assistance.

Free Application for Federal Student Aid (FAFSA)

www.fafsa.gov

The FAFSA allows students to apply for federal and state financial aid including fee waivers, grants, student loans, and work-study. All students are strongly encouraged to complete and submit the FAFSA online. Those who qualify automatically are granted a California Promise Grant Fee Waiver. Please use the Las Positas College Federal School Code 030357.

California Dream Act Application (CADAA)

<https://dream.csac.ca.gov/>

The CADAA allows undocumented students who meet AB540 eligibility criteria to apply for state-based financial aid including fee waivers and Cal grants, and the CADAA allows qualified students to participate in the EOPS Program. Students must submit additional documentation to the Admissions & Records Office to establish AB540 eligibility. Please use the Las Positas College School Code 030357.

California College Promise Grant (formerly BOG Fee Waiver) Application

<https://bog.openccapply.net/gateway/bog?cccMisCode=481>

The California College Promise Grant application allows students to apply for an enrollment fee waiver which waives the \$46 per unit enrollment fee. Students must meet income criteria established as well as academic and progress standards each term. It's best to file the FAFSA or CADAA so that you are considered for all possible sources of financial aid, as this application will only provide a fee waiver.

SCHOLARSHIPS

<http://www.laspositascollege.edu/financialaid/scholarships.php>

Las Positas College is proud to offer scholarships to eligible students. Scholarship criteria varies greatly and may include qualifying criteria such as scholastic achievement, athletic ability, academic major, career goal, artistic ability, academic or financial hardships, unmet financial need, and intent to transfer to a four-year college. Las Positas College's official scholarship program is offered in early Spring each year. Outside scholarship opportunities and searches are provided year-round as resources on the Financial Aid Office website.

FINANCIAL AID GENERAL INFORMATION

File Completion and Award Notification

Students who submit a FAFSA or CADAA Application are notified by email to submit all required documentation or forms to complete their financial aid file. Award notices are sent to students via the college's Zonemail email address once all documentation has been received and reviewed by the Financial Aid Office. Award details are also available via CLASS-Web.

Award Determination

Financial aid awards are based on an assumption of full-time enrollment, and are determined by student's unmet financial need and other specific criteria. Students enrolled less than full-time will actually receive less funding than what has been awarded, as student's actual payment (refund) amount is based on units of enrollment. Students are considered full-time if enrolled in 12 or more units, $\frac{3}{4}$ time if enrolled between 9 and 11.5 units, $\frac{1}{2}$ time if enrolled between 6 and 8.5 units, and less than half time if enrolled in less than 6 units.

Financial Aid Refunds

Las Positas College has contracted with BankMobile for the refunding

of financial aid to students. BankMobile offers two methods for students to receive their financial aid. Students may choose to have their financial aid transferred electronically to an existing bank account or students may elect to open a BankMobile Vibe debit card account. Students who have applied for financial aid in a previous year and have not received or have lost their debit card should contact the Financial Aid Office for assistance to establish a refund delivery method.

Late Start Classes

Financial aid disbursement for late start classes will occur the week when the late start class begins.

Pell Recalculation Date (frozen enrollment date)

Per federal regulations, units of enrollment are 'frozen' on the established Pell Recalculation Date (PRD) each semester. Pell grant recipients are considered eligible for financial aid based on their enrolled units on that specific date, and their Pell grant will be recalculated if their initial enrollment was higher than the enrollment on the PRD date. Students who previously received a higher amount of Pell than they are eligible for based on the PRD will be required to repay the difference between the amount they previously received and what they are eligible for based on enrollment on the PRD or frozen enrollment date. Students who add units after the PRD will not be eligible for additional Pell funds for those units, per federal regulations. The PRD/Frozen enrollment date for a term is typically near the 50% point.

Satisfactory Academic Progress (SAP)

Students must maintain satisfactory academic progress (SAP) each term in order to continue to be eligible for financial aid.

For federal and state student aid, which includes grants, loans and work-study, students must maintain a 2.0 term and cumulative grade point average (GPA), must maintain a minimum 67% cumulative completion rate (all units earned divided by all units attempted), and student's attempted units, including units earned at previous colleges, must not exceed 150% of the units required to complete their declared academic degree/program which is the student's maximum timeframe allowed to receive aid.

For California College Promise Grant Fee Waiver program, students must maintain a 2.0 cumulative GPA and must maintain completion of at least 50% of the cumulative units attempted. Students are subject to lose their fee waiver eligibility if they do not meet both of these academic and/or progress standards after two consecutive terms.

Fraud and Abuse

The Financial Aid Office is responsible for awarding and ensuring that financial aid funds are disbursed to eligible students. In the event there are concerns about the accuracy or truthfulness about identity information or documents provided, the Financial Aid Office will not award or disburse financial aid unless the student provides documentation of the information being questioned, including identity. If it is determined that a student has attempted or received financial aid by providing false or misleading information, failure to formally withdraw when no longer attending classes, or otherwise manipulating eligibility criteria in an attempt to receive financial aid, all funds received must be repaid, and the student will be referred to the U.S. Department of Education, Office of Inspector General, for possible investigation and prosecution for fraud.

Contact Information

For additional information, please contact the Financial Aid Office by calling (925) 424-1580, by emailing lpccfinaid@laspositascollege.edu, or by visiting the Student Services and Administration Building, Room 1650 (second floor). Information is available online by visiting www.laspositascollege.edu/financialaid.



LAS POSITAS COLLEGE

BCRC

BLACK CULTURAL RESOURCE CENTER

grow • learn • achieve

The Black Cultural Resource Center (BCRC)

Bldg. 1700 Room 1726 is a space designed for students to study, meet in groups, receive referrals for basic needs supports, and arrange for academic, transfer, or mental health counseling. It is also a place to just hangout, have engaging discussions with other classmates, or participate in fun activities such as open mics, movie nights, and game nights.

Visit our website at:

<http://laspositacollege.edu/bcrc/>



LAS POSITAS
COLLEGE



ACADEMIC & STUDENT SUPPORT SERVICES

ADMISSIONS & RECORDS

<http://www.laspositascollege.edu/admissions/>

The Admissions & Records Office is here to serve as a resource regarding admissions, registration, enrollment verification, transcript requests, grades, and evaluation of transcripts for the purpose of awarding degrees and certificates. Our mission is to provide an inclusive learning-centered institution providing educational opportunities and support for completion of students' transfer, degree, basic skills, career-technical, and retraining goals.

ASSESSMENT CENTER

<http://www.laspositascollege.edu/assessmentcenter/>

The Assessment Center guides students through self-placement into first level, transfer-level English and mathematics courses and assesses students seeking placement beyond the first level, transfer-level, English as a Second Language (ESL), Chemistry, and foreign languages. Contact the Assessment Center for more information.

ATHLETICS

<http://athletics.laspositascollege.edu/navbar-information/>

Las Positas College Athletics meets student athletes where they are and empowers them to achieve their academic and athletic goals, by providing equitable athletic opportunities, leadership skills, team work, hard work, accountability and symmetry. The mission of the Athletic Department is to provide exceptional opportunities for students interested in competing in intercollegiate athletics, and to promote success both on and off the court or field through intercollegiate participation. The Athletic Department assists student-athletes in developing the knowledge, skills and abilities to help them pursue their educational, career, athletic and personal goals.

BOOKSTORE

<http://www.LPCStore.com/>

The Las Positas College Bookstore is the college's official store equipped to sell textbooks and workbooks in addition to school supplies, apparel, uniforms, tools, refreshments, and snacks.

CALIFORNIA WORK OPPORTUNITY AND RESPONSIBILITY TO KIDS (CALWORKS)

<http://www.laspositascollege.edu/calworks/>

The CalWORKs program is dedicated to providing students who are currently receiving Temporary Assistance for Needy Families (TANF) cash aid with coordinated student services such as counseling, work study, child care, and advocacy. Our goal is to guide students through a successful educational journey that will help them achieve long-term self-sufficiency.

CAREER CENTER

<http://www.laspositascollege.edu/careercenter/>

The Career Center at Las Positas College is designed to help students select a major or educational goal that aligns with their professional interests. Career Center personnel provide resume reviews and job search assistance, as well as access to internships and jobs through the Center's job board and job fairs.

CASHIER'S OFFICE

<http://www.laspositascollege.edu/cashier/>

The Cashier's Office is responsible for collecting and processing tuition and student fees along with other miscellaneous fee payments. The Cashier's Office manages third party invoicing, the collection of

outstanding balances due to the College, and processes refunds due to over payments, class withdrawals, unit reductions, and residency status changes.

CHILD DEVELOPMENT CENTER

<http://www.laspositascollege.edu/childdevelopmentcenter/index.php>

Little Hawks Child Development Center & Lab School at Las Positas College offers an enriched social and educational experience for children. We are a model of "best practices" in the field of early education and children benefit by participating in innovative projects and personal interactions. Having a play-based philosophy, academics are integrated into the daily activities based on the children's interests. Each day children will experience small and large group times, free choice, and outdoor play. They will have enriched activities throughout the day that support their academic development. Licensed by the State of California, we are committed to providing an inclusive and diverse environment where all children, families, students and staff feel welcome. We have several enrollment options available including state funded preschool (CSPP) and LPC student scholarships through our 2GenFund and Veteran's First Program. In partnership with the ECE Department, we serve as a lab school for students pursuing a career in Early Care and Education. We offer employment opportunities for students enrolled at LPC and have an interest in working with young children. For more information on this program, please stop by Building 2300 or call 925-424-1560.

COMPUTER CENTER

<http://www.laspositascollege.edu/computercenter/>

The Computer Center, located on the 2nd floor of Building 2100 in Room 21206 is a quiet, open lab for students to work on college assignments. Computers are available on a first-come, first-served basis. Classes scheduled in the room have priority use of computers. Knowledgeable Instructional Assistants are available in person or virtually during operating hours to help students resolve or report issues, and provide instructional support.

CONCURRENT ENROLLMENT

<http://www.laspositascollege.edu/admissions/concurrent.php>

Las Positas College provides opportunities for students in 9th, 10th, 11th, and 12th grades to enroll in college-level, degree-applicable courses. Students in or entering 8th grade may be admitted through special agreements between Las Positas College and school districts. Students who desire to participate in concurrent enrollment must be recommended by their high school principal or designee and have written parental permission. Further information on the Concurrent Enrollment policy is available at the student's high school, and at the Admissions and Records Office. We are happy to be able to offer high school students the opportunity to enroll concurrently for the spring, summer, and fall terms.

COOPERATIVE AGENCIES RESOURCES FOR EDUCATION (CARE)

<http://www.laspositascollege.edu/EOPS/care.php>

The Cooperative Agencies Resources for Education (CARE) program provides a variety of services and activities to assist single parent students in achieving educational goals. They may receive additional services such as special counseling, support groups, child care, stipends, book service, transportation expense reimbursements, automotive repair and maintenance service, job search assistance, tutoring, and peer advising. To be eligible for CARE, students must be a current Extended Opportunity Programs and Services (EOPS) student, be attending college full-time, be receiving or have a child

ACADEMIC & STUDENT SUPPORT SERVICES

who is receiving California Work Opportunity and Responsibility to Kids (CalWORKs) or Temporary Assistance for Needy Families (TANF), and have a child who is under eighteen years of age.

COUNSELING

<http://laspositascollege.edu/counseling/>

The Las Positas College Counseling Department provides academic, career, and personal counseling to prospective and continuing students. Counselors help draft student educational plans, advise students on how to choose educational goals, majors, and careers, and help students complete documentation related to graduation and transfer to four-year universities. Counselors see students on a drop-in basis and by appointment.

DISABILITY RESOURCE CENTER (DRC)

<http://www.laspositascollege.edu/DSPS/>

The DRC is a product of the CA Community College Disabled Student Programs and Services (DSPS) program. The DRC provides students with access to support services, assistive technology, approved educational accommodations, specialized counseling, and more. The DRC's mission is to ensure students with disabilities have equal access in their educational endeavors and an enriching experience while pursuing their goals at Las Positas College. Students who have any type of disability (i.e. physical, psychological, medical, temporary or permanent) are encouraged to inquire. All services are voluntary and confidential.

ENGINEERING TECHNOLOGY

<http://www.laspositascollege.edu/engineering/eng-tech.php>

Engineering Technology is designed for those who want a hands-on engineering career with a focus on mechanical technology in an applied setting. The program provides students with foundational knowledge in mathematics, critical thinking, problem solving, and engineering design, as well as skills in manufacturing, fabrication, and welding so that students are able to adapt to the ever-changing modern industrial workplace.

EXTENDED OPPORTUNITY PROGRAMS & SERVICES (EOPS)

<http://www.laspositascollege.edu/EOPS/>

Extended Opportunity Programs and Services (EOPS) is an inclusive, equity driven, student success program that strives to help students succeed in college level coursework. A variety of programs, services, and activities have been directed to the identification, recruitment, retention, and transition of EOPS students to the four year college/university and/or career placement. Services can include: financial grants and book service; academic, career, and personal counseling; new student orientation and readiness programs; special assistance in tutoring and peer advising; transfer counseling; fieldtrips and cultural enrichment activities; and referral services. Program eligibility is based on educational disadvantage and demonstrated financial need through FAFSA or CADAA. All students must be full-time students and complete a required application.

FINANCIAL AID & SCHOLARSHIPS

<http://www.laspositascollege.edu/financialaid/>

The purpose of Financial Aid & Scholarship Office is to ensure that each student has sufficient resources to enable them to attend college. We provide grants, fee waivers, scholarships, loans, and federal work-study. Financial aid funds are provided to help with all costs of attending college, including enrollment fees, book and supplies, room and board, other personal and living expenses, transportation, child

care, and computers. Students do not have to be a full-time student to be eligible for most forms of financial aid, but full-time students do receive the maximum amount of financial aid available.

ESL LAB

<http://www.laspositascollege.edu/ilc/>

English as a Second Language ESL students enrolled in Reading and Writing courses will complete a weekly 50 minute lab assignment in the Integrated Learning Center. Students will complete lab assignments with a focus on grammar, vocabulary, reading and writing skills, in groups and/or independently with the support of an ESL instructor. Students can also access other learning support materials located in the lab.

INTERNATIONAL STUDENTS

<http://www.laspositascollege.edu/international/>

The mission of the International Students Program (ISP) is to facilitate the successful transition of international students to Las Positas College and the American educational system. The program staff takes pride in offering strong student support services at every level, beginning with preadmission advisement and continuing through to graduation or transfer. The staff strives to counsel students on academic, career, and personal issues to facilitate their progress toward successful completion of educational goals. Additionally, the ISP staff advises students on United States Citizenship and Immigration Services (USCIS) rules and regulations related to maintaining international student status.

LAS POSITAS COLLEGE STUDENT GOVERNMENT (LPCSG)

<http://www.laspositascollege.edu/lpcsg/>

LPCSG is a non-partisan organization focused on promoting student involvement on-campus and advocating for student interests. LPCSG is committed to removing barriers to access, promoting student success, and providing an atmosphere for better learning and personal growth at Las Positas College.

LIBRARY

<http://www.laspositascollege.edu/library/>

Las Positas College Library's mission is to support the college's educational programs, curriculum, and instructional philosophy. The library provides reference and public services, research skills classes, access to a collection of print and electronic resources, study spaces, and computer labs. The Library collaborates with faculty and appropriate college groups to ensure that the Library supports the learning needs and styles of a diverse student population.

MATH LEARNING CENTER

<http://www.laspositascollege.edu/math/openmathlab.php>

The Math Learning Center provides recommended support to students in math through credit or tuition-free (noncredit) support courses that are aligned with the math course and designed with innovative strategies to provide math and learning support while taking a math class. Free drop-in math help is also offered to students enrolled in Las Positas College mathematics classes through enrollment in the noncredit NMAT 202C course. The Math Learning Center is staffed with LPC Mathematics faculty.

ORIENTATION

New and returning students to Las Positas College are encouraged to view the online orientation or participate in an in-person orientation. The orientation is designed to help students navigate the steps

ACADEMIC & STUDENT SUPPORT SERVICES

to enroll, learn of support services, highlight important dates and timelines, and includes general information about the college. The link to orientation is located within CLASS-Web.

PUENTE PROJECT

<http://www.laspositascollege.edu/puente/>

Established in 1981, the Puente Project is a nationally award-winning program that has empowered numerous educationally underserved students to successfully enroll in four-year colleges and universities, attain degrees, and subsequently give back to their communities as influential leaders and mentors for upcoming cohorts. Puente achieves this through accelerated instruction, comprehensive academic counseling, and mentoring facilitated by community members.

READING & WRITING CENTER (RAW)

<http://www.laspositascollege.edu/RAW/>

The RAW (Reading and Writing) Center offers free online and in-person reading and writing support for any class. We also offer a paper drop-off review service. Our tutors are English and ESL faculty, and we have tutoring hours 7 days a week! This service is for enrolled LPC students. For more information, including hours of operation, please visit our website.

STUDENT HEALTH & WELLNESS CENTER

<http://www.laspositascollege.edu/healthcenter/>

Our team of medical, behavior health, and public health professionals are here to provide high quality integrated healthcare services that promote physical and psychological well-being, treats minor health issues, helps students navigate the healthcare and insurance systems, and strives to empower students to have a healthy and successful academic experience.

STUDENT LIFE

<http://laspositascollege.edu/studentlife/>

The Student Life Office is committed to providing programs and services that foster student participation and engagement in college governance, student activities, and cultural events through our Las Positas College Student Government (LPCSG) and our clubs/organizations. The College recognizes the important role of students as active and meaningful participants in the shared governance decision-making processes of the institution. The Student Life Office provides students with opportunities to strengthen their knowledge, expand their understanding of governance issues, increase their preparedness, and apply their leadership development skills through co-curricular engagement.

TRANSFER CENTER

<http://www.laspositascollege.edu/transfercenter/>

Las Positas College offers guaranteed transfer admission to over 95 colleges and universities. Six University of California (UC) campuses, nine California State University (CSU) campuses, more than 40 private/independent colleges, and more than 40 out-of-state universities offer guaranteed admission to students who meet specific requirements. By participating in a Transfer Admission Guarantee (TAG), Associate Degree in Transfer (ADT) program, or Transfer Admissions Agreement (TAA), you may be eligible for an early review of your academic records, early admission notification, and specific guidance about major preparation and general education coursework. Meet with a Las Positas College counselor to develop a student educational plan (SEP) to meet your transfer goals.

TUTORING CENTER

<http://www.laspositascollege.edu/tutorialcenter/>

The Tutoring Center is dedicated to students' education success by providing quiet study spaces and free high-quality learning support relevant to the individual needs of the diverse student population. We strive to create a welcoming, empathetic, and supportive environment so all students can become independent, active, and life-long learners.

UMOJA

<http://www.laspositascollege.edu/umoja/>

Umoja@LPC is a learning community that provides a support system to help students reach their academic and life goals. While all students are invited to enroll, Umoja is designed to foster the success of Black and African American students. To do this, Umoja students gain a dedicated academic counselor and accessible faculty who are determined to see students succeed in the midst of barriers and life challenges. Umoja students also take linked classes for two semesters to help them form bonds, develop leadership skills, build cultural affirmation, and work toward success. The courses that Umoja students take are in the fields of college success, transfer planning, English, and Library Skills. All courses center African and African American experiences, voices, writers, speakers, and topics. Lastly, to foster learning and goal achievement, students are invited to attend college tours and culturally-enriching conferences and events, which are usually free-of-cost to students. For more information, contact Danielle Odom at dodom@laspositascollege.edu or Salem Admassu at sadmassu@laspositascollege.edu. To apply, go to <https://laspositas.umojacommunity.org/>.

VETERANS FIRST

<http://www.laspositascollege.edu/veterans/>

Veterans First Program provides support services to those who have served in the armed forces, those currently serving in the armed forces, reservists/guard, and dependents and spouses of Veterans. We are primarily responsible for the administration of Veterans educational benefits. In addition, we provide resources and referrals, such as career planning, financial aid, transition counseling services, and other needed services for our returning Veterans. We encourage all to contact our office in-person, by telephone, or by e-mail (lpveteransfirst@laspositascollege.edu) with any questions pertaining to one's education, or any Veterans Affairs educational benefits. We can and will assist with the application and processing of your Veterans Affairs benefits at Las Positas College.

WORK-BASED LEARNING PROGRAM

<http://www.laspositascollege.edu/careercenter/work-based.php>

Las Positas College provides clear academic and career pathways to improve the workforce and economy of our community. To support this mission, the college offers a Work-Based Learning Program - a collaboration with local business and industry to develop career and work experience opportunities, internships and mentoring programs, and community work and study placements directly related to a vocational field of training. This partnership benefits both employers and students, ensuring a talent pipeline of skilled workers from the college to the workplace and reinforcing and expanding students' classroom learning. As part of the Work-Based Learning Program, Las Positas College offers courses and an internship and job board. In Work Experience courses, students learn 21st century work skills and earn college credit for working. Learn more at <http://www.laspositascollege.edu/workexperience/>.

The Las Positas College Internship and Job Board connects students and alumni with area employers. Register at <http://laspositascollege.edu/internship-job-board>.

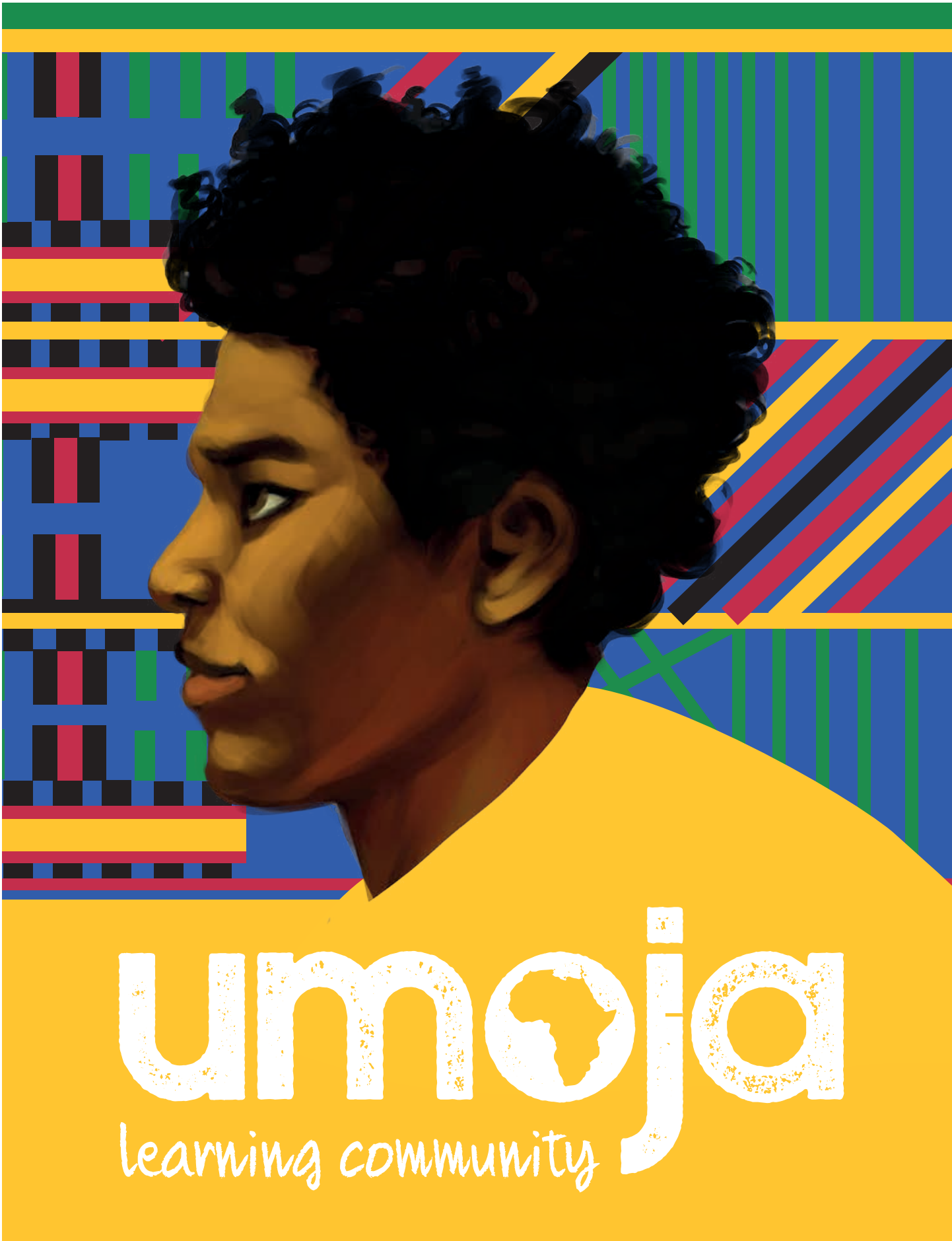

umojja

learning community

The Umoja Community is a...

College success program and learning community that provides a dedicated support system to help you reach your academic goals and life purpose. You will have a dedicated counselor and personal tutor as well as a host of faculty who are readily available to guide you. You will experience college success and English curriculum focused on African-American experiences through literature, history, and artistic modalities.

Through the UMOJA PROMISE you can complete courses in the program to be eligible to transfer to an HBCU/Private University in ONE year! You can also be eligible to transfer to a UC or CSU within TWO years!

WHAT WILL YOU RECEIVE?

You will receive the following:

- Encouraging and supportive instructors
- Cohort classes (this means you will take classes with other Umoja students) — it's a community!
- Dedicated counselor
- Personal tutor
- College workshops
- Guest speakers
- College tours
- School supplies
- Access to transfer events
- A supportive community of faculty and other thriving students, for example the Black Student Union (BSU) student club

WHO CAN BE A PART OF THIS COMMUNITY?

If you are committed to successfully achieving your educational goals and completing your program of study (i.e., certificate, associate's degree or transfer), this program is for you!

WHO IS ELIGIBLE?

Any student who is enrolled at Las Positas College or has begun the admissions process and has assessed into English 1A – Critical Reading and Composition.

UMOJA PROMISE PROGRAM MODEL

You will take courses with other Umoja students which are taught by our Umoja specific faculty. Some of your courses will be Fast-Track courses (8 -week courses) to help you complete your academic goal sooner.

Fall Semester:

Psychology-Counseling 30 – Student Success & Career Exploration *

- 3 units
- CSU/UC transferable course: CSU GE: E

English 1A – Critical Reading and Composition *

- 3 units (8 week fast-track)
- CSU/UC transferable course: CSU GE: A2; IGETC: 1A

English 4 - Critical Thinking and Writing *

- 3-unit (8 week fast- track)
- CSU/UC transferable course: CSU GE: A1; IGETC: 1C

Spring Semester:

Psychology 21– Psych of Race & Identity

- 3 units
- CSU/UC transferable course: CSU GE: D; IGETC: 4

Communication Studies 1- Public Speaking

- 3 units (8 week fast-track)
- Can be taken during Fall or Spring
- CSU/UC transferable course: CSU GE:A1; IGETC: 1C

**Zoom attendance possible for students who are unable to attend.*



APPLY NOW!



CONTACT INFORMATION

Danielle Odom

Counselor/Umoja Co-Coordinator
dodom@laspositascollege.edu
(925) 424-1445

Salem Admassu

English Instructor/Umoja Co-Coordinator
sadmassu@laspositascollege.edu
(650) 516-7994

For more information about the Umoja Program, please visit their website: <http://laspositascollege.edu/umoja> IG: **Umoja_LPC**

COLLEGE POLICIES & PROCEDURES

ACADEMIC FREEDOM

Academic freedom exists and is nurtured in our community for the common good of all citizens. Students, faculty, administrators and society itself derive benefits from the practice of academic freedom with its open search for truth and its free exposition. Academic freedom is fundamental for the protection of the instructor's right in teaching and the student's right in learning in the classroom and on the campus. Academic freedom carries with it responsibilities correlative with rights, such responsibilities being implicit in all freedoms and assured by all members of the college to insure the rights of others.

ACADEMIC HONESTY

Las Positas College is dedicated to maintain an optimal learning environment and insists upon academic honesty and adherence to standards of student conduct. To uphold the academic integrity, all members of the academic community shall assume responsibility for providing an educational environment of the highest standard characterized by academic honesty. It is the responsibility of all members of the academic community to encourage learning, promote honesty, and act with fairness. Student conduct at Las Positas College must conform to federal and state laws and college district policies and procedures.

CLASS SCHEDULE AND CATALOG

The class schedule and college catalog are publications of Las Positas College. They provide information regarding course and program offerings including dates, times, prerequisites, and course descriptions. You may obtain the publications at the College Bookstore, download them from the College website, or by accessing CLASS-Web or The ZONE online. The class schedule is available in alternate format. Contact the Disability Resource Center at (925) 424-1510 for assistance.

COMMUNICABLE DISEASE

The Student Health & Wellness Center is the entity at Las Positas College that is responsible for working with Alameda County Public Health Department in communicable disease control.

CONSUMER INFORMATION

The federal Higher Education Act, the federal Equity in Athletics Disclosure Act, and regulatory guidance provided in the Code of Federal Regulations require notification of prescribed information to certain target audiences including prospective students, currently enrolled students, current employees, parents, coaches and counselors of prospective student athletes, and the general public. Disclosures are to include crime/security statistics, student completion/graduation rates, privacy/security rights, financial aid program information, and gender-specific information on athletic participation and financial support. Detailed information and corresponding reports are found online on the college website.

COPYRIGHT INFORMATION

It is policy of the college district that employees and students must adhere to the United States Copyright Law (Title 17, United States Code) when using materials for instructional, institutional, or any other purpose.

DISCLAIMERS, LAS POSITAS COLLEGE

WEBSITE DISCLAIMER

The Chabot-Las Positas Community College District (CLPCCD) attempts to maintain the highest accuracy of content on its websites. Any errors or omissions should be reported for investigation.

CLPCCD makes no claims, promises, or guarantees about the absolute accuracy, completeness, or adequacy of the contents of this website and expressly disclaims liability for errors and omissions in the contents of this website. No warranty of any kind, implied, expressed, or statutory, including but not limited to the warranties of non-infringement of third-party rights, title, merchantability, fitness for a particular purpose, and freedom from computer virus, is given with respect to the contents of this website or its hyperlinks to other Internet resources. Reference in this website to any specific commercial products, processes, or services, or the use of any trade, firm, or corporation name is for the information and convenience of the public, and does not constitute endorsement, recommendation, or favoring by the CLPCCD or its employees or agents.

This website has links to sites that may be useful to the public and that may provide other services or information. When the user links to another website, which is not an authorized CLPCCD website, the user is no longer on a CLPCCD website. The CLPCCD disclaims any responsibility or liability for the services or information provided on non-CLPCCD websites.

PHOTOGRAPHY DISCLAIMER

Chabot and Las Positas Colleges, being non-profit California Community Colleges, reserve the right to use photography and video images of students and visitors, age 18 and older, taken on our property and at college-sponsored events for marketing and promotional purposes. Objection to the use of an individual's photograph may be made in writing to the district office of marketing and public relations, addressed to:

Director, Public Relations, Marketing and Government Relations
Chabot-Las Positas Community College District
7600 Dublin Blvd., 3rd Floor
Dublin, CA 94568
prmg@clpccd.org

DISTANCE EDUCATION

Las Positas College offers quality distance education to its students. Distance education allows students who work, raise families, are disabled, are environmentally conscious, or who otherwise cannot come to campus the ability to pursue their educational goals.

COLLEGE POLICIES & PROCEDURES

EQUAL OPPORTUNITY STATEMENT

Las Positas College is an equal opportunity action institution in its policies, procedures, and practices relating to access, admission, and employment in their programs, services, and activities. In compliance with federal law, Las Positas College does not discriminate on the basis of race, color, national origin, religion, sex, disability, age, citizenship status, and genetic information. In addition, California state law also prohibits discrimination on the basis of race, color, ancestry, national origin, religion, sex (including pregnancy, childbirth, and related medical conditions), disability (physical or mental), age, genetic information, marital status, sexual orientation, gender identify and gender expression, AIDS/HIV, medical condition, political activities or affiliations, military or veteran status, and status as a victim of domestic violence, assault, or stalking. Inquiries regarding equal opportunity non-discrimination policies and procedures that pertain to student matters should be directed to the Las Positas College, Vice President of Student Services by calling (925) 424-1405. All non-student matters (including employment matters) should be directed to the Vice Chancellor of Human Resources by calling (925) 485-5200.

FAMILY EDUCATIONAL RIGHTS AND PRIVACY ACT (FERPA)

According to the U.S. Department of Education, FERPA “is a Federal law that protects the privacy of student education records. The law applies to all schools that receive funds under an applicable program of the U.S. Department of Education.” At Las Positas College, a person officially becomes a student upon receipt of an admission application to the college.

FREE SPEECH

College procedures regarding time, place, and manner shall govern the exercise of free speech and related activities on the campus. The responsibility for maintaining conduct within the bounds of the law and compliance with the policies of the Chabot-Las Positas Community College District Board of Trustees shall be assumed by individuals, organizations, and the sponsoring organization’s officers and student organizations, advisors, and all organizational members. Restrictions on speech content shall extend no further than to restrain speech that is obscene, libelous, or presents a clear and present danger.

HOUSING

Las Positas College does not provide dormitories or other types of college-sponsored housing.

NET PRICE CALCULATOR

The California Community Colleges Chancellor’s Office, in conjunction with the federal government, has developed a Net Price Calculator to help students estimate the cost to attend Las Positas College based on residency and living arrangements. The estimated cost of attendance includes tuition, required fees, textbooks, supplies, and other related expenses. This

information is found on the college website at <https://misweb.cccco.edu/npc/481/npcalc.htm>.

NOTICE OF NONDISCRIMINATION

The Chabot-Las Positas Community College District is committed to equal opportunity in educational programs, employment, and all access to institutional programs and activities. The District, and each individual who represents the District, shall provide access to its services, classes, and programs without regard to national origin, religion, age, gender, gender identity, gender expression, race or ethnicity, color, medical condition, genetic information, ancestry, sexual orientation, marital status, physical or mental disability, pregnancy, or because he/she is perceived to have one or more of the foregoing characteristics, or based on association with a person or group with one or more of these actual or perceived characteristics. Inquiries and complaints may also be made to the U.S. Department of Education, Office for Civil Rights, 50 United Nations Plaza, San Francisco, CA 94102, telephone (415) 486-5555, fax (415) 486-5570 or e-mail OCR.SanFrancisco@ed.gov.

DECLARACIÓN DE NO DISCRIMINACIÓN

(SPANISH STATEMENT)

Las Positas College, de acuerdo con las leyes civiles, declara que Las Positas College no discrimina hacia ninguna persona a base de su raza, color, nacionalidad, ascendencia, religión, creencia, sexo, edad o incapacidad, en sus programas y políticas de empleo y educación. El conocimiento limitado del idioma no limita acceso a programas y servicios ocupacionales. Cualquier pregunta sobre la aplicación de esta declaración puede dirigirse al U.S. Department of Education, Office for Civil Rights, 50 United Nations Plaza, San Francisco, CA 94102, teléfono (415) 486-5555, fax (415) 486-5570 o correo electrónico OCR.SanFrancisco@ed.gov.

OMBUDS

The Ombuds (also known as an “ombudsman” or “ombudsperson”) at Las Positas College will be an identified employee(s) who is committed to serve as a neutral and an impartial conflict resolution practitioner. The Ombuds will have no formal decision-making authority or disciplinary responsibilities. The Ombuds will serve as the initial point of contact for students who encounter challenges or difficulties while navigating the college environment and will be responsible for identifying the proper resource at the college. Furthermore, the Ombuds will facilitate the first connection or contact with the appropriate college entity or employee. The goal of the Ombuds is to ensure the rights and interests of all parties to the dispute are considered with the goal of achieving a fair outcome in accordance with applicable policies, procedures, laws, and regulations. The inability to achieve a fair outcome may result in the student being referred to the grievance or complaint process. For more information, please contact the Office of the Vice President of Student Services.

COLLEGE POLICIES & PROCEDURES

PROGRAMS ELIGIBLE FOR FINANCIAL AID

In order to be eligible for federal student aid, a student must be enrolled in an educational program that leads to an associate degree, transfers into a baccalaureate program, or prepares a student for gainful employment in an approved and recognized occupation. Students must either: (1) declare an Associate's Degree Program, or Associate's Degree with Transfer Program as their educational goal; or (2) be enrolled in a non-degree Certificate of Achievement Program of at least sixteen units and one year in length that is included and approved on the college's Program Participation Agreement with the U.S. Department of Education.

STUDENT CONDUCT AND DUE PROCESS

In joining the academic community, the student enjoys the right of freedom to learn and shares the responsibility in exercising that freedom with other members of the academic community. It is the policy of the Chabot-Las Positas Community College District not to impose student discipline for acts occurring away from the college and not connected with college activities unless the student's conduct affects the function of the college. When a student is charged with violating the student conduct code (e.g., plagiarism, forgery, disruption, theft, etc.), the charge shall be processed in accordance with the policy and procedures in order to protect the student's rights and the college's interests. A student may be expelled, suspended, placed on probation, or given a lesser sanction, as deemed appropriate by the Student Conduct Officer or designee. The Student Conduct Code is posted online on the college website and included in the college catalog.

STUDENT GRIEVANCE PROCEDURES

Student Grievance Procedures have been developed to provide students with a prompt and equitable means of seeking an appropriate remedy for any alleged violation of rights and to ensure that each student is fully accorded due process. The Student Grievance Procedures and the Student Conduct and Due Process Procedures outline the process for seeking resolution, and develop the procedure for filing and processing complaints, including timelines and decision-making authority. Student Grievance information is found online on the college website and included in the college catalog.

VOTER REGISTRATION INFORMATION

The Chabot-Las Positas Community College District shall provide a good faith effort to distribute a mail voter registration form to each student enrolled in a degree or certificate program and physically in attendance at the institution. Forms are widely available to students at Las Positas College. Additional information is found on the college website and the online student portal.

STUDENT RIGHT-TO-KNOW (INSTITUTIONAL DATA)

**Fall 2019 Cohort, Completion Rate: 46.59%,
Transfer Rate: 13.41%**

In compliance with the Student-Right-to-Know and Campus Security Act of 1990 (Public Law 101-542), it is the policy of our college district to make available its completion and transfer rates to all current and prospective students. Beginning in Fall 2019, a cohort of all certificate-, degree-, and transfer-seeking first-time, full-time students were tracked over a three-year period. Their completion and transfer rates are listed above. These rates do not represent the success rates of the entire student population at the College nor do they account for student outcomes occurring after this three-year tracking period.

Based upon the cohort defined above, a Completer is a student who attained a certificate or degree or became 'transfer prepared' during a three-year period, from Fall 2019 to Spring 2022. Students who have completed 60 transferable units with a GPA of 2.0 or better are considered 'transfer-prepared'. Students who transferred to another postsecondary institution, prior to attaining a degree, certificate, or becoming 'transfer-prepared' during a five-semester period, from Spring 2020 to Spring 2022, are transfer students.

COMMUNICATION IS KEY!

All registration notices, Financial Aid and general College information, will be emailed to your Zonemail Account. Check it regularly! We want to make sure you have all the information you need to be successful in your time at Las Positas College. Please keep in touch and review all emails and communication from us when you receive it!

How to Forward Your ZoneMail to Your Personal Email:

1. Login to your ZONEmail account at <https://myportal.clpccd.cc.ca.us>
2. Click the email option
3. In the upper right hand corner, click the Setting icon and select "Mail Settings"
4. Click the "Forwarding and POP/IMAP" tab
5. Click "Add a Forwarding Address" and type your personal email
6. Access your personal email account to retrieve the verification code, then enter it into the box and click "Verify"
7. Select the option to "Forward a copy of incoming mail" to your personal email.
8. Save changes

CAMPUS SAFETY & SECURITY

ACCESS TO BUILDINGS

During business hours, the College and most campus buildings are open from 7:00 am to 11:00 pm. During non-business hours, access to all College facilities is by key or card key, if issued, or by admittance via the assistance of the Office of Campus Safety and Security. In the case of periods of extended closing, the College will admit only those with prior approval to all facilities. All students and employees are issued identification cards, which they may be asked to produce if there is any question about their authorization to be on College property.

CAMPUS SAFETY

The Chabot-Las Positas Community College District is committed to a safe and secure work and learning environment. The Office of Campus Safety & Security prepares and annually updates a report of all occurrences reported to the Office of Campus Safety & Security of and arrests for crimes that are committed on-campus and that involve violence, hate violence, theft or destruction of property, sexual misconduct including sexual harassment, illegal drugs, alcohol intoxication, and of all occurrences of noncriminal acts of hate violence reported to campus authorities. Additional information and corresponding reports are found on the College website.

COLLEGE PROPERTY

No College property may be removed from the campus without expressed permission from an administrator. Unauthorized removal of College property from the campus is a violation of the law and may be prosecuted by the College.

CRIME PREVENTION

Crime prevention material is distributed by the Office Campus Safety and Security to the campus community. The Office of Campus Safety and Security makes inspections of facilities to ensure physical security design, presents programs to reduce risk from criminal acts, review plans and new construction additions to facilities to insure against design defects that could contribute to criminal acts, make preventative patrols of grounds, make necessary arrests and detentions, and interact with other law enforcement and investigative agencies to accomplish this task.

DRUG FREE ENVIRONMENT AND PREVENTION PROGRAM

Las Positas College strives to maintain a drug-free and alcohol-free environment. College district policy states it prohibits, "the sale or knowing possession of dangerous drugs, restricted dangerous drugs, alcoholic beverages or narcotics as those terms are used in California statutes except when lawfully prescribed or permitted." Federal law also prohibits the use, sale, or possession of marijuana. Students may be arrested, suspended, expelled, placed on probation or given a lesser sanction for good cause and in accordance with College procedures consistent with due process for violations of the drug and alcohol policy. Students and employees will be informed of the health risks associated with the use of illicit drugs and the abuse of alcohol, and will be advised of the availability of drug and alcohol counseling, treatment, and rehabilitation.

EMERGENCY CALL BOXES

Emergency call boxes are also located in several parking lots, on the campus perimeter road, and near the Student Services & Administration Building. In the event of an emergency, push the button on the emergency call box and the on-duty campus security

officer is notified of your location. The emergency call box has a feature which allows the caller to speak directly to the campus safety officer. Outside the entrance to the Office of Campus Safety and Security there is an emergency auto-dialer. In the case of an emergency and the office is locked, please push the button on the auto-dialer. The auto-dialer will contact the on-duty campus safety officer.

EMERGENCY NOTIFICATION

The Las Positas College Office of Campus Safety and Security is committed to ensuring that our campus community receives timely, accurate, and useful information in the event of a significant emergency or dangerous situation on campus or in the local area that poses an immediate threat to the health and safety of campus community members. Las Positas College uses the emergency notification system "Everbridge" which is an emergency notification service that proactively contacts students, staff, and faculty at their District assigned e-mail accounts. Everbridge can be used to send emergency messages within minutes of the occurrence of an incident. Messages are sent by multiple methods to contact information listed in the campus directory as well as confidential contact information registered by users. The system can send simultaneous messages to the college community by e-mail message and SMS text. Campus community members can contact the Office of Campus Safety and Security to update or change their contact information and are encouraged to list "SMS Text" as their primary contact method.

EMERGENCY PROCEDURES

Las Positas College Office of Campus Safety and Security personnel are available twenty-four (24) hours a day, seven (7) days per week. Persons are encouraged to report any criminal activity or any other emergency by calling the Office of Campus Safety and Security by calling (925) 424-1699 or visiting the Office of Campus Safety and Security located in Building 1700. If the Office of Campus Safety and Security is closed, the on-duty campus safety officer can be contacted by telephone in the following ways:

- On-campus telephone, dial extension 1690 (non-emergency)
- On-campus telephone, dial extension 1699 (emergency)
- Off-campus telephone, dial (925) 424-1000 until 6:30 p.m.

LOST AND FOUND

The Office of Campus Safety & Security takes great pride in returning lost and found property to their rightful owners. All property found on-campus should be brought to the Office of Campus Safety and Security located in Building 1700 to be recorded. All found property is held for and disposed of in the manner prescribed by law.

PARKING

Parking on-campus is a privilege extended by the Chabot-Las Positas Community College District Board of Trustees to the faculty, staff, students, and guests. To ensure safety and the efficient use of available parking spaces, parking rules and regulations adopted by the Board of Trustees are enforced all year. Tickets will be issued for violators. Drivers using College parking lots shall comply with the rules and regulations adopted by the Board of Trustees pursuant to California Vehicle Code, Section 21113. Failure to comply with the parking rules and regulations may result in disciplinary action, the issuance of a parking citation, loss of parking privileges, and/or cause the vehicle to be towed at the owner's expense. Parking at Las Positas College is by permit only.

CAMPUS SAFETY & SECURITY

PARKING PERMITS

Parking at Las Positas College is by digital permit only. Full-term digital parking permits may be purchased online via parking permit portal. Daily digital parking permits may be purchased from parking permit machines located in the parking lots. All students and guests must purchase a digital parking permit for each day. Take notice that certain parking spaces are reserved for College employees and College vehicles. These parking spaces are clearly marked in front of the parking stall. Vehicles parked in a staff or other reserved space without the proper permit will be cited. All vehicles shall be parked clearly within designated parking stalls between the white lines and head-in only. Do not back in or drive through.

PETS ON CAMPUS

No animals and/or pets of any kind or description are allowed within the boundaries of the college. This restriction also applies to animals and/or pets confined to any vehicle parked within the college boundaries. This policy does not apply to the use of a guide dog, signal dog, or service dog specially trained for assisting a person with a disability.

SAFETY ESCORT SERVICES

The Office of Campus Safety and Security offers escorts to the campus community to and from the parking lots. To arrange to have an escort accompany you from your classroom or office to your vehicle by dialing (925) 424-1690, or from any College telephone by dialing extension 1690, or by activating a nearby emergency callbox.

SEX OFFENDER REGISTRY

California law requires sex offenders who are employed, volunteer, are a resident of, or enrolled as a student at an institution of higher education, to register with the Livermore Police Department located at 1110 South Livermore Avenue, Livermore, CA 94550. To search the database of registered sex offenders in California by name or geography, check the Megan's Law website at <https://www.meganslaw.ca.gov/> or information concerning registered sex offenders can be obtained from the Livermore Police Department.

SMOKING ON CAMPUS

Smoking is allowed only within designated smoking areas and is prohibited within 20 feet of a main exit, entrance, or operable window of any campus or District building. Smoking is prohibited inside any indoor area of any campus or District building and inside any District-owned or leased vehicles. Smoking is prohibited in any enclosed place of employment on-campus, including lobbies, lounges, waiting areas, stairwells, and restrooms that are a structural part of any building that is a place of employment. This also applies to electronic cigarettes or other imitation smoking devices.

STATEMENT FOR NON-SWORN OFFICERS

The Chabot-Las Positas Community College District employs security officers with training specific to campus security.

STATEMENT OF ENFORCEMENT AUTHORITY

The campus safety officer meets the legal definition of a security officer because of appointment pursuant to the California Education Code, Section 70902. The campus safety officer is not a peace officer, but Sections 626 and 627 of the California Penal Code provide special authority for school security officers to make an arrest if the

perpetrator fails to leave the College grounds after being directed to do so. In addition to this authority, campus safety officers can arrest for any misdemeanor or felony committed within their presence, but must use section 837 of the California Penal Code – arrest by a private person – to accomplish the arrest. Campus safety officers derive additional authority from Section 21113(a) of the California Vehicle Code. This section covers parking on school property. Officers can issue citations for violations of District Parking Regulations using this section.

TIMELY WARNING

In an effort to provide timely notice to the campus community in the event of a Clery Act crime that may pose a serious or on-going threat to members of the community, Las Positas College Office of Campus Safety and Security will issue out a "Timely Warning." The Office of Campus Safety and Security will generally issue these warnings for the following crimes: criminal homicide; sexual assaults; robbery; aggravated assault; arson; burglary; and hate crimes. The Office of Campus Safety and Security will post these warnings through a variety of ways including, but not limited to, e-mail messages, posters or bulletins, and class discussions. The purpose of these warnings is to notify the campus community of the incident and to provide information that may enable community members to protect themselves from similar incidents. The Office of Campus Safety and Security will issue these warnings whenever the following criteria are met:

1. A crime is committed;
2. The perpetrator has not been apprehended; and
3. There is a substantial and on-going risk to the physical safety of other members of the campus community because of this crime.

Such crimes include, but are not limited to: Clery Act crimes that are reported to any campus security authority or the local police; or when the college determines that the incident represents an on-going threat to the campus community. Additionally, the Office of Campus Safety and Security may, in some circumstances, issue warnings when there is a pattern of crimes against persons or property. The Campus Safety Supervisor or designee will generally make the determination, in consultation with the President, if a warning is required. However, in emergency situations, any Campus Safety Officer may authorize a Clery Timely Warning. For incidents involving off-campus crimes, the college may issue a Crime Advisory if the crime occurred in a location used and frequented by the college population. Clery Timely Warnings are sent out to the campus community via the Everbridge system. If you have an official Las Positas College e-mail address, you are automatically enrolled in the crime alert notification system. These messages are a very effective way to share important information with the campus community about safety.

TITLE IX

Title IX of the Educational Amendments of 1972 is an all-encompassing federal law that prohibits discrimination based on the gender of students and employees of educational institutions which receive federal financial assistance. Under Title IX, discrimination on the basis of sex can include sexual harassment, rape, and sexual assault. Colleges and universities that receive federal financial assistance may be held legally responsible when it knows about and ignores sexual harassment or assault in its programs or activities. Colleges and universities may be held responsible in court whether the harassment is committed by a College employee or student. Title IX related

CAMPUS SAFETY & SECURITY

concerns and complaints of possible violations of Title IX should be reported to the Vice President of Student Services or designee.

WEAPONS POLICY

Firearms, knives, explosives or other dangerous chemicals or objects, including, but not limited to, any facsimile firearm, knife or explosive, are prohibited on College property and all College-sponsored functions at all times. All weapons are prohibited at Las Positas College. Except for sworn law enforcement officials, it is a felony to bring or possess any firearm on any California school campus per California Penal Code, Section 626.9. It is also a felony to possess any air gun, including pellet and BB guns that utilizes air, CO2, or spring pressure to propel a metallic projectile; knives with a blade length of over 2.5 inches, dirks, daggers, and ice picks are also illegal per California Penal Code, Section 626.10. Any person may be arrested, expelled, suspended, placed on probation or given a lesser sanction for good cause and in accordance with College procedures consistent with due process for violations of the weapons policy.

CRIME STATISTICS / CLERY ACT DISCLOSURE / ANNUAL SECURITY REPORT (ASR)

The Office of Campus Safety and Security prepares a report to comply with the Jeanne Clery Disclosure of Campus Security Policy and Crime Statistics Act. Crime statistics may be found online at www.laspositascollege.edu/safety/statistics.php. The full text of this report may be found online at www.laspositascollege.edu/safety/documents/clery.pdf. The report is prepared in cooperation with the local law enforcement agencies. Campus crime, arrest, and referral statistics include those reported to the Office of Campus Safety and Security, designated campus officials including, but not limited to, administrators, faculty, classified professionals, advisors to students and student organizations, athletic coaches, and local law enforcement agencies.

**Clery Act Statistics
Las Positas Community College
2020 – 2022**

20 U.S.C. 1092 H (Crimes) Criminal Offenses	2020			2021			2022		
	On Campus Property	Non Campus Property	Public Property	On Campus Property	Non Campus Property	Public Property	On Campus Property	Non Campus Property	Public Property
Murder/Non-negligent Manslaughter	0	0	0	0	0	0	0	0	0
Negligent Manslaughter	0	0	0	0	0	0	0	0	0
Rape	0	0	0	0	0	0	0	0	0
Fondling	0	0	0	0	0	0	1	0	0
Incest	0	0	0	0	0	0	0	0	0
Statutory Rape	0	0	0	0	0	0	0	0	0
Robbery	1	0	0	0	0	0	0	0	0
Aggravated Assault	0	0	0	0	0	0	0	0	0
Burglary	0	0	0	0	0	0	0	0	0
Motor Vehicle Theft	0	0	0	0	0	0	0	0	0
Arson	0	0	0	0	0	0	0	0	0
Domestic Violence	0	0	0	0	0	0	0	0	0
Dating Violence	0	0	0	0	0	0	0	0	0
Stalking	0	0	0	0	0	0	0	0	0
Bias Crimes	On Campus Property	Non Campus Property	Public Property	On Campus Property	Non Campus Property	Public Property	On Campus Property	Non Campus Property	Public Property
Disability	0	0	0	0	0	0	0	0	0
Ethnicity	0	0	0	0	0	0	0	0	0
Gender	0	0	0	0	0	0	0	0	0
Race	0	0	0	0	0	0	0	0	0
Religion	0	0	0	0	0	0	0	0	0
Sexual Orientation	0	0	0	0	0	0	0	0	0
Arrests	On Campus Property	Non Campus Property	Public Property	On Campus Property	Non Campus Property	Public Property	On Campus Property	Non Campus Property	Public Property
Weapons Violations	0	0	0	0	0	0	0	0	0
Drug Law Violations	0	0	0	1	0	0	0	0	0
Liquor Law Violations	0	0	0	0	0	0	0	0	0
Disciplinary Referrals	On Campus Property	Non Campus Property	Public Property	On Campus Property	Non Campus Property	Public Property	On Campus Property	Non Campus Property	Public Property
Weapons Violations	0	0	0	0	0	0	0	0	0
Drug Law Violations	0	0	0	0	0	0	0	0	0
Liquor Law Violations	0	0	0	0	0	0	0	0	0

PARKING PERMITS AVAILABLE ONLINE

Semester parking permits are now **DIGITAL**, and registered to your license plate.

~ YOU WILL NOT RECEIVE A PHYSICAL PERMIT ~

\$45
per semester

\$30
Fee Waiver students

\$20
Motorcycle



Before purchasing a permit you will need the following information:

- ✓ An email address
- ✓ Vehicle license plate number
- ✓ Make, model, color of vehicle

To purchase a permit:

- Log into CLASS-Web, go to "Student Services"
- Click on "Order Parking Permit"
- Continue by following the on-screen instructions
- Also available at the Las Positas College main website under "Parking Permits"

Students must purchase a DIGITAL parking permit each semester to park on campus. If you do not have a digital semester permit registered to your vehicle, daily digital permits are available for \$3.00 – look for the parking permit machines located in the parking lots.

Don't Be The Last To Know!

Everbridge is the emergency alert system used to deliver timely and necessary emergency alerts.

To receive these alerts, students, faculty and staff can sign up as follows:

- Sign into CLASS-Web using your W ID Number and PIN.
- Click on the Personal Information tab.
- Click on 'Update Emergency Text-Authorized Cell Phone Number'.
- Enter your cell phone number to be used and click Submit.
- To opt out - after first message received, reply STOP.

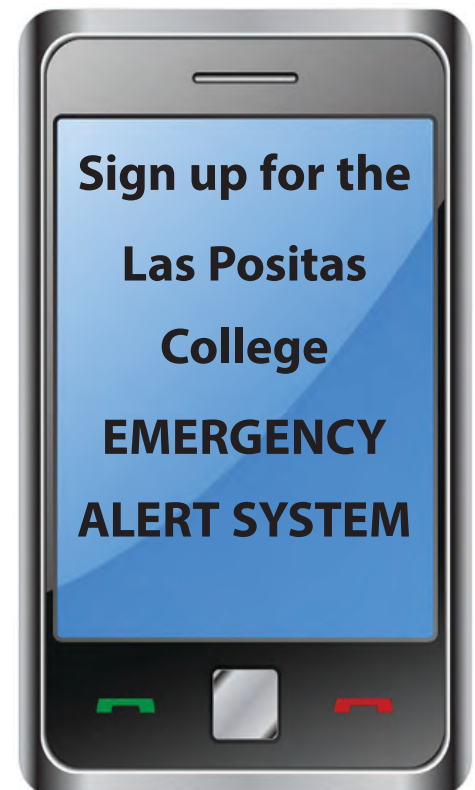

LAS POSITAS COLLEGE BOOKSTORE

HAS EVERYTHING YOU NEED TO HAVE THE **BEST YEAR EVER!**

Affordable Text Options

- Rental
- Used

Las Positas Merch

- Clothing
- Gifts

Convenience Items

- Testing Materials
- Campus Print Cards
- Snacks
- Headphones

Las Positas College Bookstore
Building 1300
(925) 424-1812 | LPCStore.com

Over 10% of our sales go back to Las Positas College to support student success

LAS POSITAS COLLEGE Transit Pass

**Your Las Positas College
ID is your bus pass!**

- Ride all Wheels and Rapid routes
- Connects to Dublin/Pleasanton BART, the Livermore Labs, and the Livermore Transit Center
- Rapid Route 30R comes to campus every 15 minutes
- Free Wi-Fi, upgraded seating, and phone charging outlets

Livermore Amador Valley
TRANSIT AUTHORITY



*Think of all
your extra time...*



wheelsbus.com | (925) 455-7500

SPRING 2024 FINAL EXAM SCHEDULE

Spring 2024 final examinations for full-term classes will be held May 18, 2024 - May 24, 2024. Your final exam might not always occur at the same time as your class. Please carefully check the chart below to determine the time and day of your final exam. The schedule below applies to final exams given in face-to-face classes, hybrid courses (online with in-person meetings for exams, labs, or skills instruction), and online courses taught synchronously. Instructors teaching online asynchronously, or a combination of asynchronous and synchronous, will clarify their final exam instructions on the class syllabus. This final exam schedule applies to full-term classes only.

The first hour and the first day of the week that day classes meet determines placement of the final exam. In determining the examination time for lecture-laboratory classes and lecture-discussion courses, the lecture period determines the time. For stand-alone lab course (with its own CRN Number), a two-hour final examination will be given during final examination week. The first hour and the day of the week that the laboratory class meets will determine the placement of the class in the schedule below. If you have a question about when and where your final exam will take place, please contact your instructor.

Day Classes (Classes beginning before 4:00pm)

Start Time and Days of Regular Class Meeting		Time and Day of Final Examination		
<i>Predominantly Monday/Wednesday</i>				
7:30am, 8:00am	MTWTh, MTWF, MWThF, MTThF, MWF, MT, MW, MTh, MF, WF, M	7:30–9:20am	Wednesday	May 22
8:30am, 9:00am	MTWTh, MTWF, MWThF, MTThF, MWF, MT, MW, MTh, MF, WF, M	7:30–9:20am	Monday	May 20
9:30am, 10am	MTWTh, MTWF, MWThF, MTThF, MWF, MT, MW, MTh, MF, WF, M	9:30–11:20am	Wednesday	May 22
10:30am, 11am	MTWTh, MTWF, MWThF, MTThF, MWF, MT, MW, MTh, MF, WF, M	9:30–11:20am	Monday	May 20
11:30am, 12:00 noon	MTWTh, MTWF, MWThF, MTThF, MWF, MT, MW, MTh, MF, WF, M	11:30am–1:20pm	Wednesday	May 22
12:30pm, 1:00pm	MTWTh, MTWF, MWThF, MTThF, MWF, MT, MW, MTh, MF, WF, M	11:30am–1:20pm	Monday	May 20
1:30pm, 2:00pm	MTWTh, MTWF, MWThF, MTThF, MWF, MT, MW, MTh, MF, WF, M	1:30–3:20pm	Wednesday	May 22
2:30pm, 3:00pm	MTWTh, MTWF, MWThF, MTThF, MWF, MT, MW, MTh, MF, WF, M	1:30–3:20pm	Monday	May 20
3:30pm	MTWTh, MTWF, MWThF, MTThF, MWF, MT, MW, MTh, MF, WF, M	3:30–5:20pm	Wednesday	May 22
<i>Predominantly Tuesday/Thursday</i>				
7:30am, 8:00am	TWTh, TW, TTh, TF, ThF, WTh, T, TWThF, MTTh, TThF	7:30–9:20am	Thursday	May 23
8:30am, 9:00am	TWTh, TW, TTh, TF, ThF, WTh, T, TWThF, MTTh, TThF	7:30–9:20am	Tuesday	May 21
9:30am, 10:00am	TWTh, TW, TTh, TF, ThF, WTh, T, TWThF, MTTh, TThF	9:30–11:20am	Thursday	May 23
10:30am, 11:00am	TWTh, TW, TTh, TF, ThF, WTh, T, TWThF, MTTh, TThF	9:30–11:20am	Tuesday	May 21
11:30am, 12:00 noon	TWTh, TW, TTh, TF, ThF, WTh, T, TWThF, MTTh, TThF	11:30am–1:20pm	Thursday	May 23
12:30pm, 1:00pm	TWTh, TW, TTh, TF, ThF, WTh, T, TWThF, MTTh, TThF	11:30am–1:20pm	Tuesday	May 21
1:30pm, 2:00pm	TWTh, TW, TTh, TF, ThF, WTh, T, TWThF, MTTh, TThF	1:30–3:20pm	Thursday	May 23
2:30pm, 3:00pm	TWTh, TW, TTh, TF, ThF, WTh, T, TWThF, MTTh, TThF	1:30–3:20pm	Tuesday	May 21
3:30pm	TWTh, TW, TTh, TF, ThF, WTh, T, TWThF, MTTh, TThF	3:30–5:20pm	Thursday	May 23

SPRING 2024 FINAL EXAM SCHEDULE

Classes starting before 7:30am, or classes meeting W, Th, or F only before 4:00pm

Start Time and Days of Regular Class Meeting		Time and Day of Final Examination		
5:30am, 6:00am	Daily	Regular class time	Friday	May 24
6:45am, 7:00am, 7:30am, 8:00am, 8:30am, 9:00am	Before 7:30, or W, Th, F only before 4pm	7:30–9:20am	Friday	May 24
9:30am, 10:00am, 10:30am, 11:00am	Before 7:30, or W, Th, F only before 4pm	9:30–11:20am	Friday	May 24
11:30am, 12:00 noon, 12:30pm 1:00pm	Before 7:30, or W, Th, F only before 4pm	11:30am–1:20pm	Friday	May 24
1:30pm, 2:00pm, 2:30pm, 3:00pm	Before 7:30, or W, Th, F only before 4pm	1:30–3:20pm	Friday	May 24
3:30pm	Before 7:30, or W, Th, F only before 4pm	3:30–5:20pm	Friday	May 24

Classes that meet “By Arrangement”

Start Time and Days of Regular Class Meeting		Time and Day of Final Examination		
By Arrangement	All classes that meet “By Arrangement”	3:30–5:20pm	Friday	May 24

Classes meeting on or after 4:00pm

Start Time and Days of Regular Class Meeting		Time and Day of Final Examination		
4:00pm and ending by 7:30pm	MW, or Monday Only	5:30pm–7:20pm	Wednesday	May 22
4:00pm and ending by 7:30pm	TTh, or Tuesday Only	5:30pm–7:20pm	Thursday	May 23
4:00pm and ending by 7:30pm	Wednesday only	5:30pm–7:20pm	Monday	May 20
4:00pm and ending by 7:30pm	Thursday only	5:30pm–7:20pm	Tuesday	May 21
4:00pm and ending by 7:30pm	Friday only	5:30pm–7:20pm	Friday	May 24
6:30pm or after	MW, or Monday only	7:30pm–9:20pm	Wednesday	May 22
6:30pm or after	TTh, or Tuesday only	7:30pm–9:20pm	Thursday	May 23
6:30pm or after	Wednesday only	7:30pm–9:20pm	Monday	May 20
6:30pm or after	Thursday only	7:30pm–9:20pm	Tuesday	May 21
6:30pm or after	Friday only	7:30pm–9:20pm	Friday	May 24

Weekend Classes: All Saturday classes have their finals in their regular room at the regular class time scheduled on Saturday, May 18, 2024.

Fast Track and Late Start Classes: Final exams held during the last 2 hours of the last class meeting.

Online Classes: Consult your instructor for final exam information.

NOTE: This information is subject to change. Please find the most updated information online.

CAMPUS DIRECTORY

Admission & Records	424-1500	Integrated Learning Center (ILC)	424-1310
<i>Building 1600, Room 1670</i>		<i>Building 2100, Room 2119</i>	
Assessment Center (Testing)	424-1475	International Student Program	424-1540
<i>Building 1600, Room 1642</i>		<i>Building 1600, Room 1658</i>	
Athletics	424-1274	Library	424-1151
<i>Building 2500, Room PE116</i>		<i>Building 2000</i>	
Black Cultural Resource Center (BCRC)	424-1085	Math Learning Center	424-1310
<i>Building 1700, Room 1726</i>		<i>Building 2100, Room 2119</i>	
Bookstore	424-1812	Ombuds	424-1406
<i>Building 1300, Room 1300</i>		<i>Building 1600, Room 1669</i>	
Cafeteria	424-1849	Outreach	424-1407
<i>Building 1600, Room 1620</i>		<i>Building 1600, Room 1643</i>	
CalWORKs	424-1459	Puente Project	424-1414
<i>Building 1600, Room 1668</i>		<i>Building 1000, Room 1018</i>	
Campus Safety & Security	424-1690	Reading and Writing Center (RAW)	424-1450
<i>Building 1700, Room 1725</i>		<i>Building 2100, Room 21215, Office E</i>	
CARE Program	424-1598	Student Government	424-1490
<i>Building 1600, Room 1668A</i>		<i>Building 1600, Room 1643</i>	
Career Center	424-1487	Student Health & Wellness Center	424-1830
<i>Building 1600, Room 1604</i>		<i>Building 1700, Room 1701</i>	
Cashier's Office	424-1500	Student Life	424-1496
<i>Building 1600, Room 1670</i>		<i>Building 1600, Room 1643</i>	
Child Development Center	424-1560	Transfer Center	424-1423
<i>Building 2300</i>		<i>Building 1600, Room 1604</i>	
Community Education	424-1467	Tutorial Center	424-1450
<i>Building 1600, Room 1690</i>		<i>Building 2100, Room 21215</i>	
Computer Center	424-1144	UMOJA	424-1437
<i>Building 2100, Room 21206</i>		<i>Building 1700, Room 1726</i>	
Concurrent Enrollment	424-1500	Veterans First Program	424-1570
<i>Building 1600, Room 1670</i>		<i>Building 1300, Room 1310</i>	
Counseling	424-1400		
<i>Building 1600, Room 1616</i>			
Disabled Student Programs & Services (DSPS)	424-1510		
<i>Building 1600, Room 1615</i>			
Engineering Technology	424-1254		
<i>Building 1800, Room 1825</i>			
Extended Opportunity Programs & Services (EOPS)	424-1598		
<i>Building 1600, Room 1668</i>			
Financial Aid & Scholarships	424-1580		
<i>Building 1600, Room 1650</i>			
Information Desk	424-1000		
<i>Building 1600, Room 1630</i>			

OFF-CAMPUS INSTRUCTIONAL SITES

Amador Valley High School
1155 Santa Rita Road
Pleasanton, CA 94566

Livermore Adult Education School
1401 Almond Avenue #A
Livermore, CA 94550

Dublin High School
8151 Village Parkway
Dublin, CA 94568

Tri-Valley Golf Center
1780 Freisman Road
Pleasanton, CA 94588

Leo R. Croce Elementary School
5650 Scenic Avenue
Livermore, CA 94551

Village High School
4645 Bernal Avenue
Pleasanton, CA 94566

LAS POSITAS COLLEGE CAMPUS MAP

3000 Campus Hill Drive, Livermore, CA 94551 • www.laspositascollege.edu

KEY TO BUILDINGS

400	Middle College	2300	Child Development Center (CDC)
500	Math Classrooms	2400	Multi-Disciplinary Education Building
600	Future Construction Project (STEAM)	2401	Cultural Community Center
700	Graphic Design & Digital Media Lab, Photography Lab & Studio	2420	Lecture Hall
800	Viticulture & Winery Technology, Future Construction Project (STEAM)	2500	Physical Education Complex (Gym)
1000	Classroom Building	2600	Aquatic Center
1100	Central Utility Plant	2700	Campus Hill Vineyard
1300	Bookstore	3000	Maintenance & Operations Building (M&O)
1310	Veterans First Program	3100	Maintenance & Operations Building (M&O)
1600	Student Services & Administration Building	3200	Field House
1690	Academic Services, Vice President's Office	3300	Horticulture
1689	Administrative Services, Vice President's Office	3400	Public Safety Center
1670	Admissions & Records	3500	Advanced Manufacturing & Transportation
1642	Assessment Center	3600	Viticulture & Winery Technology (Under Construction)
1668	California Work Opportunity & Responsibility to Kids (CaWORKS)	3700	Viticulture & Winery Technology (Under Construction)
1604	Career/Transfer Center	4000	Mertes Center for the Arts
1690	Community Education		4128 Black Box Theater
1668	Cooperative Agencies Resources for Education (CARE)		4119 Main Stage Theater
1616	Counseling		Facilities Management Office
1615	Disabled Students Programs & Services (DSPS)		FMO
1668	Extended Opportunity Programs & Services (EOPS)		
1650	Financial Aid		
1658	International Student Program		
1680	President's Office		
1672	Registration Support Center		
1643	Student Life, Student Government (LPCSG)		
1669	Student Services, Vice President's Office		
1643	Welcome Center		
1700	Campus Safety, Health Center, Ricoh, Mail Room, BCRC		
1726	Black Cultural Resource Center (BCRC)		
1717	Copy Center (Ricoh)		
1700	Mail Room		
1710	Student Health Center		
1800	Science Technology Center 1		
1850	Science Technology Center 2		
1900	Information Technology Services (ITS)		
2000	Library		
2100	Academic Support & Office Building		
21206	Computer Center		
21108	English Center		
21220	Honors Program		
21119	ILC/Math Learning Ctr/ESL		
21117	Math Emporium		
21215	Tutoring Center		

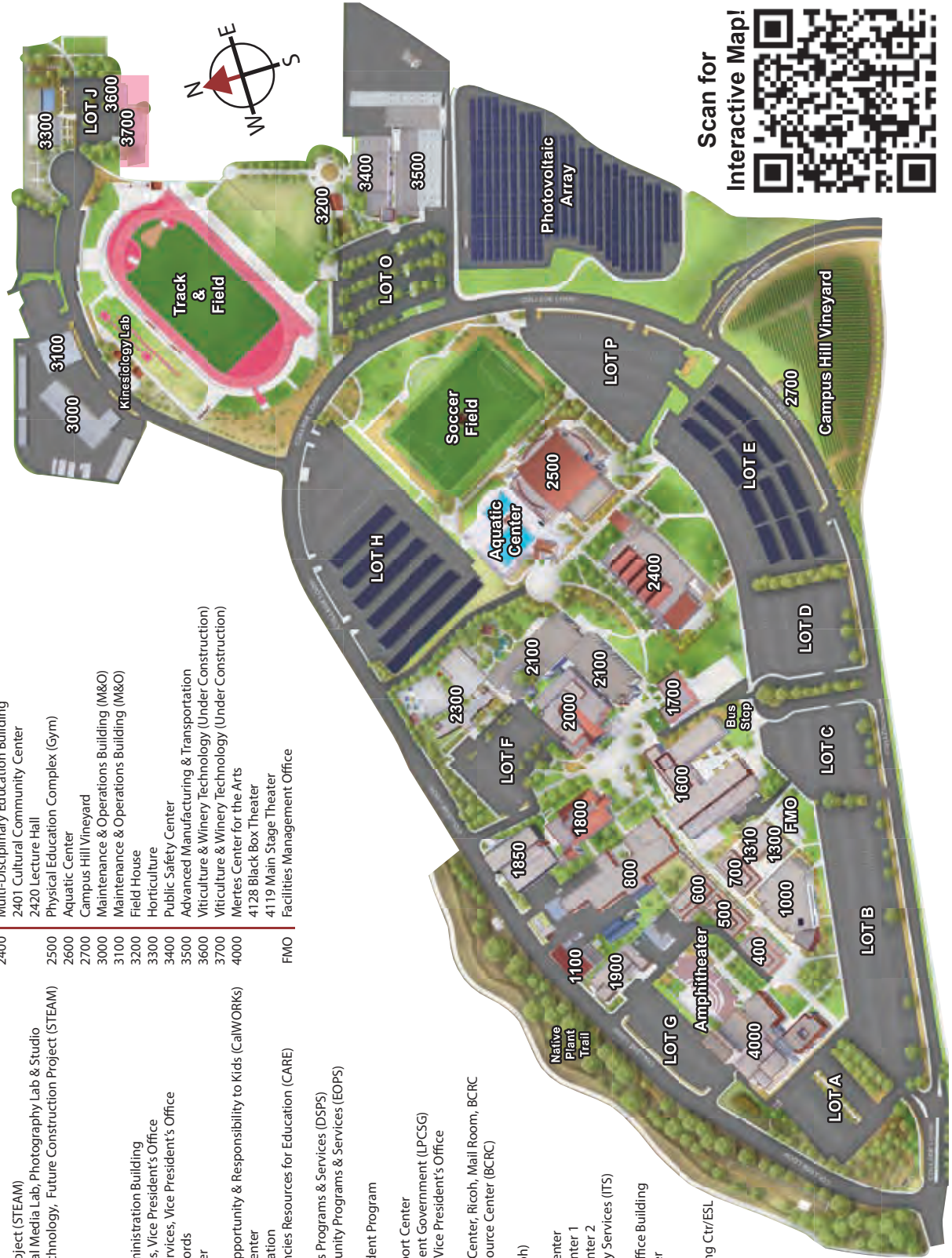

Scan for
Interactive Map!



NEW! 3D CAMPUS MAP



SCAN ME!

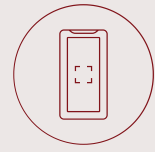

TO VIEW OUR NEW 3D CAMPUS MAP



WAYFINDING TO SHOW YOU DIRECT PATHS FROM POINT A TO POINT B



FIND BUILDINGS, CLASSROOMS, STUDENT SERVICES, TUTORING, AND MORE!



VIEW PARKING LOTS, DAILY PERMITS AND PUBLIC TRANSPORTATION



FIND FOOD SERVICES INCLUDING THE CAFETERIA, VENDING & COFFEE MACHINES

STUDENT HIGHLIGHT



I chose LPC for its paramedic program.

I spoke with former students from previous cohorts and they had great reviews. After doing my research, LPC was the most affordable option compared to other paramedic programs in Northern California. I was in the middle of a career change in which I had a manufacturing job for 10 years and recently received my EMT certification from another community college. The campus was conveniently located in between my EMT job in the East Bay and my home in the Central Valley. I am married and have three children so picking the right program that fits into my work schedule and my home life was a high priority. LPC gave me the tools and the knowledge to become a paramedic. On the journey the instructors and staff treated me like a person, not a number. The staff were flexible and adapted to my learning style when needed. Paramedic school is grueling, intense and stressful which makes choosing the right program extremely important. I will forever be grateful to the paramedic program of LPC. The campus is a great place to learn. LPC had all the resources I needed to achieve my career goals. It is a fun and safe learning environment. Last but not least I enjoyed the camaraderie amongst my classmates. You can't put a price on that! COHORT 9 FOREVER.

James Straley

Certification: NREMT-P

Transferred from Modesto Junior College

Current employment: Paramedic, Falck Alameda County



3000 Campus Hill Drive
Livermore, CA 94551-7623
Tel: 925.424.1000
www.laspositascollege.edu

NON PROFIT ORG.
U.S. POSTAGE
PAID
LIVERMORE, CA
PERMIT NO. 116

ECRWSS

RESIDENTIAL CUSTOMER

LAS POSITAS COLLEGE OPEN HOUSE

COLLEGE COURSES FOR HIGH SCHOOL STUDENTS

**SATURDAY, MARCH 23 2024
10AM – 2PM**

Visit our beautiful LPC campus on March 23, 2024 to see why Las Positas College was ranked the #1 Community College in California and the #4 Community College in America! Tour the campus, meet staff and faculty members, and take part in interactive sessions featuring a wide array of student services and support programs offered at LPC.



SCAN TO
RSVP



**LPC CONCURRENT
ENROLLMENT FOR SPRING,
SUMMER & FALL**

Concurrent Enrollment at Las Positas College offers high school students an exciting opportunity to get ahead in their college journey. Students can explore diverse subjects, earn valuable college credits, and build a strong foundation for future academic and career success.

For more information about the LPC's Concurrent Enrollment program, please visit www.laspositascollege.edu/admissions/concurrent.php or scan the QR Code.

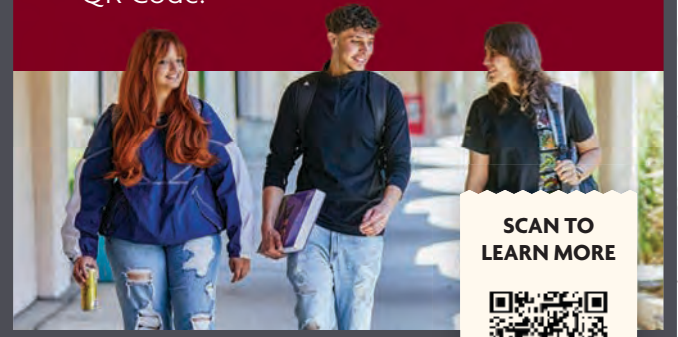

SCAN TO
LEARN MORE

